

Digital Congress Network



The **DCN**

Digital Congress Network

Alphanumeric Index

Index of DCN equipment by part number

LBB 3015/04	High-Quality Dynamic Headphones	3.12, 4.11
LBB 3312/00	Suitcase for DCN Discussion Units	2.12
LBB 3440/00	Lightweight Headphones	3.12
LBB 3440/50	Replacement Ear Pads for LBB 3440/00 Headphones	3.12
LBB 3441/00	Under the Chin Headphones	3.12
LBB 3441/50	Replacement Eartips for LBB 3441/00	3.12
LBB 3442/00	Single Earphone	3.12
LBB 3500/05(D)	Basic Central Control Unit	4.2
LBB 3500/15(D)	Extended Central Control Unit	4.3
LBB 3500/35(D)	Multi Central Control Unit	4.5
LBB 3501/00	19" Rack Mounting Set	8.2
LBB 3504/00	Suitcase for Central Control Unit LBB 3500/xx	2.13
LBB 3506/00(D)	Extension Power Supply Unit	4.7
LBB 3508/00(D)	Audio Media Interface and Power Supply Unit	4.8
LBB 3510/00	Network Card for Personal Computer	4.9
LBB 3511/00	PC Card for Multi-CCU Systems	4.9
LBB 3512/00	Data Distribution Board	4.10, 6.2
LBB 3513/00	Analog Audio Input/Output Module	3.5
LBB 3514/00	Trunk-Cable Splitter	8.1
LBB 3515/00	Tap-Off Unit	8.1
LBB 3516/xx	Extension Cable Assembly	8.2
LBB 3516/00	100 m Installation Cable	8.2
LBB 3517/00	Set of 25 Cable Locking Clamps	8.2
LBB 3518/00	Termination Plug for DCN cable	3.10
LBB 3519/20	Trunk Communication Board	4.10
LBB 3520/10	Interpreter Desk with LCD Screen	3.3
LBB 3524/00	Electronic Channel Selector Panel	3.7
LBB 3524/10	Electronic Channel Selector Panel with Backlighting	3.8
LBB 3525/00	Table-Top Housing for Channel Selector	3.10
LBB 3526/10	Electronic Channel Selector Panel with Backlighting	3.9
LBB 3527/00	Table-Top Housing for Loudspeaker LBB 3538/00	2.22
LBB 3530/00	Delegate Discussion Unit	2.8
LBB 3530/50	Delegate Discussion Unit with Long Microphone	2.8
LBB 3531/00	Delegate Discussion Unit with Channel Selector	2.9
LBB 3531/50	Delegate Discussion Unit with Channel Selector and Long Microphone	2.9
LBB 3533/00	Chairman Discussion Unit	2.10
LBB 3533/50	Chairman Discussion Unit with Long Microphone	2.10
LBB 3534/00	Chairman Discussion Unit with Channel Selector	2.11
LBB 3534/50	Chairman Discussion Unit with Channel Selector and Long Microphone	2.11
LBB 3535/00	Dual Audio Interface Unit	2.15
LBB 3536/00	Hand-Held Microphone	2.16
LBB 3536/10	Hand-Held Microphone with Coiled Cable	2.16
LBB 3537/00	Microphone with Control Panel	2.17
LBB 3537/10	Chairman Priority Control Panel	2.18
LBB 3537/20	Pluggable Microphone Control Panel	2.17

Introduction

DCN Contribution Equipment

Interpretation and Language Distribution Equipment

DCN Central Control Equipment

Application Software

DCN Information Displays

Cameras and Accessories

Installation Equipment

Technical Data

Digital Congress Network

Alphanumeric Index

LBB 3537/50	Microphone with Extended Stem Length and Control Panel	2.17
LBB 3538/00	Loudspeaker Panel	2.19
LBB 3539/00	Blanking Panel	2.22
LBB 3540/15	Multi-Purpose Connection Unit	2.19
LBB 3541/00	Delegate Voting Control Panel	2.20
LBB 3542/00	Delegate/Chairman Voting Control Panel with LCD Screen	2.21
LBB 3542/20	Delegate/Chairman Voting Control Panel with Cyrillic LCD Screen	2.21
LBB 3543/15	Chip-Card Reader Panel	2.22
LBB 3544/00	Standard Delegate Unit	2.3
LBB 3545/00	Delegate Unit with Channel Selector	2.4
LBB 3546/00	Delegate Unit with Graphic LCD and Chip-Card Reader	2.5
LBB 3547/00	Chairman Unit with Graphic LCD and Chip-Card Reader	2.6
LBB 3549/00	Pluggable Microphone	2.3, 2.18
LBB 3549/50	Pluggable Microphone with Extended Stem Length	2.3, 2.18
LBB 3555/00	Intercom Handset and Cradle	2.7, 3.6, 4.10
LBB 3556/00	Mounting Plate for LBB 3555/00	3.6
LBB 3557/00	Chip Card Encoder	4.11
LBB 3559/05	Set of 100 Chip Cards	4.11
LBB 3562	Stand-alone version of DCN Automatic Camera Control Module	5.14
LBB 3570	Microphone Management Software Module	5.2
LBB 3571	Synoptic Microphone Control Software Module	5.3
LBB 3572	Simultaneous Interpretation Software Module	5.5
LBB 3573	Intercom Software Module	5.6
LBB 3575	Parliamentary Voting Software Module	5.7
LBB 3576	Multi Voting Software Module	5.8
LBB 3578	Attendance Registration Software Module	5.9
LBB 3580	Delegate Database Software Module	5.9
LBB 3581	ID-Card Encoder Software Module	5.10
LBB 3582	Message Distribution Software Module	5.11
LBB 3583	Text/Status Display Software Module	5.11
LBB 3584	Video Display Software Module	5.12
LBB 3585	System Installation Software Module	5.13
LBB 3586	Multi-CCU Control Software	5.14
LBB 3587	Open Interface Software	5.15
LBB 3588	Control-PC version of DCN Automatic Camera Control Module	5.14
LBB 3590	DCN Startup screen	5.2
LBB 4002/00	Profecta Acoustic Feedback Suppressor	2.24
LBB 9095/30	Interpreter Headphones	3.4
LBB 9510/20	Hand-Held Microphone	2.23
LBB 9514/20	Gooseneck Microphone	2.23
LBB 9526/10	Lavalier Microphone	2.23
LBC 1215/01	Universal Microphone Clamp	2.24
LBC 1221/01	Floor Stand	2.24
LBC 1226/01	Adjustable Boom	2.24
LTC 0450	Digital Colour Cameras	7.5

Digital Congress Network

Alphanumeric Index

LTC 0829/00	AutoDome System.....	7.4
LTC 2814	Colour Video Monitor.....	7.6
LTC 2917/90	Colour Video Monitor.....	7.6
LTC 8200	Allegiant Video Switcher.....	7.2
LTC 8555	Allegiant Keyboard	7.3
WMS 2700	VHF Multi-Channel Microphone System	2.24
8222 231 16451	Replacement Ear Pads for LBB 3015/04 Headphones	3.12, 4.10
Audipack 6399	Suitcase for Interpreter Units	2.12
Audipack 6400	Suitcase for Interpreter Units and CCU.....	2.12
Audipack 12759	Suitcase for DCN Concentus Units and Microphones.....	2.13
Alphanumeric Hall Display.....		6.2
Geographic Display.....		6.2
Numeric Hall Display		6.2

Introduction

DCN Contribution Equipment

Interpretation and Language Distribution Equipment

DCN Central Control Equipment

Application Software

DCN Information Displays

Cameras and Accessories

Installation Equipment

Technical Data

1

2

3

4

5

6

7

8

9

INDEX

Digital Congress Network

Digital Congress Network

The Complete Conference Management System

Registered Trademarks

Microsoft, MS-DOS and Windows are registered trademarks of the Microsoft Corporation.

Pentium is a registered trademark of the Intel Corporation.

Compaq is a registered trademark of the Compaq Computer Corporation.

IBM, Operating System/2 and OS/2 are registered trademarks of the International Business Machines Corporation.

Digital Congress Network

The Complete Conference Management System

1. Introduction

Digital Congress Network	1.1
Contribution Equipment	1.3
Interpretation and Language Distribution Equipment	1.4
Central Control Equipment	1.5
Application Software	1.6
Information Distribution Equipment	1.7
Examples	1.8

2. DCN Contribution Equipment

Overview	2.1
Table-Top Contentus Units	2.3
Accessories	2.9
Suitcases	2.12
Table-Top Discussion Units	2.8
Flush-Mounted Units	2.14
Accessories	2.23

3. Interpretation and Language Distribution Equipment

Overview	3.1
Simultaneous Interpretation Equipment	3.3
Wired Language Distribution Equipment	3.7
Wireless Language Distribution Equipment	3.11
Headphones and Accessories	3.12

4. DCN Central Control Equip- ment

Overview	4.1
Control Units	4.2
Power Supplies	4.7
Extension Cards	4.9
Accessories	4.10
Personal Computers	4.12

5. Application Software

Overview	5.1
Startup	5.2
Application Modules	5.2
Multi-CCU Control Software	5.14

6. DCN Information Displays

Overview	6.1
Hall Displays	6.2

7. Cameras and Accessories

Overview	7.1
Allegiant Video Switcher System	7.2
Dome Systems	7.4
Cameras	7.5
Monitors	7.6

8. Installation Equipment

Cables and Accessories	8.1
------------------------------	-----

9. Technical Data

Specifications	9.1
----------------------	-----

Index

Alphanumeric Index	i.1
--------------------------	-----

Introduction

DCN Contribution Equipment

Interpretation and Language Distribution Equipment

DCN Central Control Equipment

Application Software

DCN Information Displays

Cameras and Accessories

Installation Equipment

Technical Data

Index

Using this catalogue

The section numbers listed on this page cover the main systems and individual categories within these groups for convenient reference.

It is possible to locate any section quickly by thumbing to the corresponding tab number on the outer margin of each page. The index section at the back of this catalogue includes an alphanumeric listing according to part number.

1

2

3

4

5

6

7

8

9

INDEX

Digital Congress Network

The Complete Conference Management System

Digital Congress Network

Digital Congress Network



World's first digital congress system

The Philips Digital Congress Network (DCN) brings the benefits of innovative digital technology to discussion, conference and congress systems. Digital signal processing and transmission via a simple network system not only offers great improvements in audio quality, but simplifies operation and installation. The DCN control system has the option of modern, user-friendly software to setup and control conferences, although it is just as easy to run an operator-free configuration.

DCN provides flexible management facilities for all types of conferences, from small, informal gatherings to international, multi-lingual congresses with thousands of delegates. It is the first entirely digital system of its kind, and offers versatility, high audio quality data transmission security while providing complete control over conference proceedings.

Digital performance with user-friendly software control

Every requirement of modern conference management is met. There are facilities from basic microphone management, through delegate identification and registration, electronic voting, information distribution and display, up to extensive simultaneous interpretation. The DCN is above all a user-friendly system. A single operator can, with the help of the appropriate software modules, control and monitor even the largest of congresses.

Modular system approach

By simply daisy-chaining the modular DCN units, any configuration can be put together. Although the diagram on the right shows a simple discussion system, the modular structure of the DCN system means all levels of conference can be catered for without any difficulty. Systems can be expanded by adding more contribution equipment and introducing PC control with software modules.

Complete range of equipment

The full range of DCN products includes contribution units, central control units, simultaneous interpretation and language distribution equipment, application-specific software modules, information display systems and installation equipment. This is complemented by external equipment such as video and dot matrix displays, PCs, monitors, booster amplifiers, loudspeakers and printers, all of which are fully compatible and easily integrated into the DCN system.

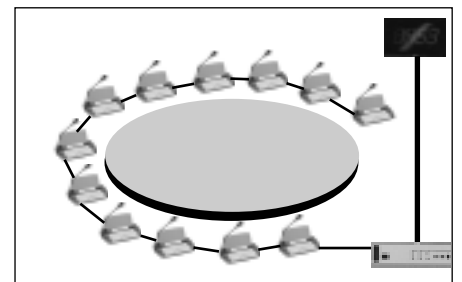

Simple 'daisy-chain' installation characterises the DCN system.

Digital Congress Network

Digital Congress Network

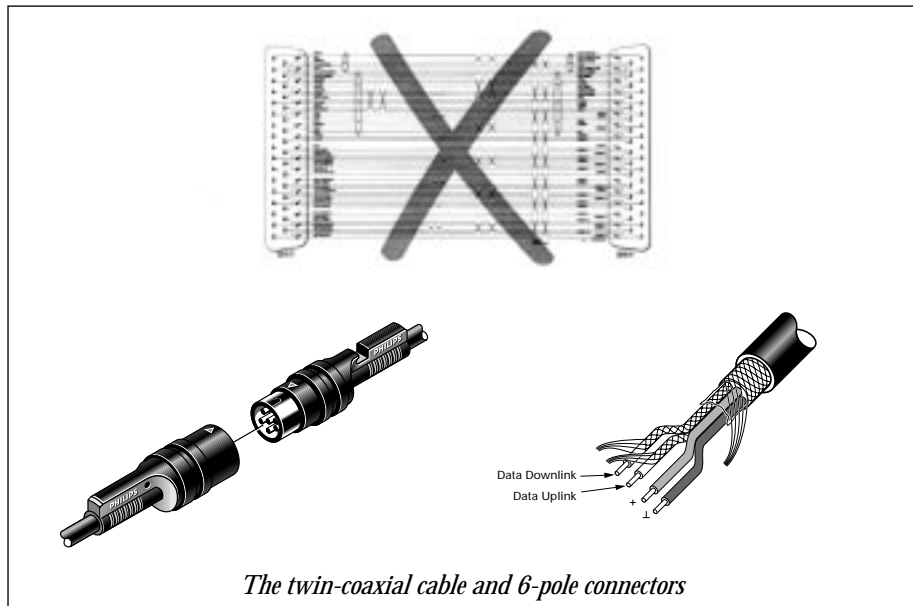
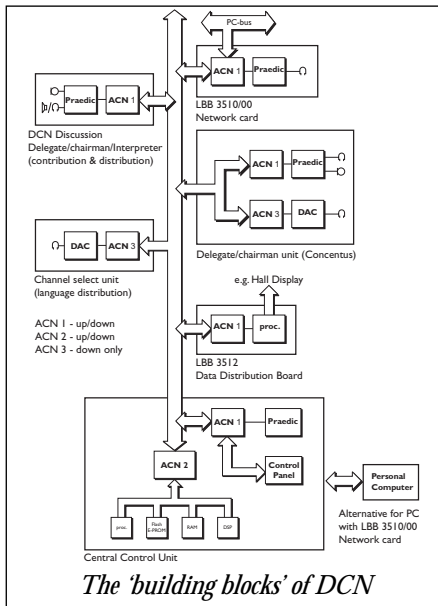

Advanced digital technology

Signal transmission and processing is handled by proven Philips digital audio technology. An example of this is the high-performance 'Bitstream' system used for analogue-to-digital conversion in delegate microphone units. This technology is integrated into custom single-chip analogue-to-digital and digital-to-analogue converters around which most DCN units are based. Other ICs specially developed for this application include dedicated protocol converter chips. The system combines the highest levels of functionality and performance in an extremely compact design.

The diagram above shows how the 'building blocks' of the DCN fit together. The Audio Communication Network (ACN) family of protocol converter chips are simply connected to the network cabling carrying the digital signal. In addition to bi-directional protocol converters for contribution equipment and central control units, there is also a uni-directional ACN chip for channel selection units for distribution only.

The Praedics (Professional Audio Encoder Decoder Integrated Circuits) are combined analogue-to-digital and digital-to-analogue converters. These devices convert the digital signal from the DCN to audio, and convert the contributor's audio signal to digital, ready for protocol conversion by the ACN chip.

Excellent audio quality

The result of this advanced digital technology is excellent audio performance with no loss in signal quality or level during transmission. Subsequently, each delegate receives an audio signal of consistently high quality, which makes a significant contribution to speech intelligibility. DCN virtually eliminates problems associated with conventional systems, such as background noise, interference, distortion and crosstalk.

Reduced installation costs

Fast, cost-saving installation is an important benefit of DCN digital technology. A thin, flexible, twin-coaxial cable carries all the system's digital signals, therefore eliminating the need for costly and vulnerable multi-core cables used in conventional analogue installations. This twin-coaxial cable can easily be run through existing ducting and cable conduits. It can simultaneously carry up to 16 high-quality contribution channels, 16 high-quality distribution channels - typically interpretation languages - plus 10 channels for messages and other data.

Simplified wiring

Gone are the days of complex wiring through bulky trunking. The diagram above shows the cable used for DCN signal transmission, and the specially moulded 6-pole connectors (configured according to the 6-pin DIN standard).

The same cable is used to transport signals to all contribution units throughout the system, and can be 'tapped' at any desired point to connect extra contribution units or other DCN equipment, thus giving rise to a 'branched-tree' topology. In this way, future extensions to the system capacity, such as adding extra microphone units or increasing the number of language channels, do not require alterations to the existing system cabling. The power is also supplied to all units via two wires in the same cable.

Installation is further simplified and speeded up by the use of splitters and ready-made cables with sturdy, moulded connectors, thus allowing easy insertion of contribution equipment at any desired point in the system cabling. These easy-to-connect accessories are used for both fixed and portable installations, making DCN a versatile system that can be installed quickly and efficiently in any conference situation.

Digital Congress Network

Contribution Equipment

Contribution equipment

Contribution equipment is the term used to describe the units via which participants can contribute to a conference.

Depending on the type of contribution unit, participants can access facilities to listen, speak, register a request-to-speak, receive screen messages, hold conversations with other participants via an intercom, take part in electronic voting sessions and receive simultaneous interpretation of the floor language.

DCN Discussion units are specially tailored for smaller gatherings and meetings, and offer a high level of functionality and digital convenience, as well as their own distinctive styling.

The most basic Cententus Contribution unit is equipped with a microphone with an on/off button, loudspeaker, voting keys and LED status indicators. More advanced units incorporate features such as graphic LCD screens, language channel selectors, softkeys and chip-card readers. Chairman units have a microphone priority system that temporarily mutes all active delegate microphones.

Table-top or flush-mounting

Contribution units can be used freestanding on a table-top, or flush mounted in desks, seat backs or armrests. Other microphone types such as gooseneck, lavalier and hand-held are also available, allowing contribution from non-seated participants such as guest speakers.

While table-top units are suitable for portable installations and for flexible system configurations where requirements regularly change, the flush-mounted units are ideal for permanent installation into conference facility furnishings.

Additional support equipment is also available, such as microphone stands, mounting facilities, suitcases for portable DCN systems and interface boards.



Table-top Cententus units for portable and flexible installations



Flush-mounted units for permanent conference facilities



DCN discussion units for smaller gatherings and meetings

Digital Congress Network

Interpretation and Language Distribution Equipment



Simultaneous interpretation and language distribution

The DCN system offers comprehensive facilities for simultaneous interpretation and distribution of the interpretations to conference participants, which allows it to meet the demands of international, multi-lingual conferences and congresses.

All interpretation facilities are fully integrated into the basic system concept, with the digital distribution of the interpretations using the same trunk-line cabling as all other system functions. It is therefore a relatively simple task to integrate language facilities into existing DCN systems.

The simultaneous interpretation system enables direct or auto-relay interpretation modes to cater for less well-known languages. Each interpreter desk has an output for the normal (primary) language and another for alternative languages.

Up to 15 different languages

The DCN interpreter desk can accommodate up to 15 different language channels (30 on request), plus the original floor language. A maximum of six desks can be installed per interpreter booth. It can be used stand-alone or as part of a comprehensive system.

When used stand-alone, the built-in microprocessor is manually programmed to allocate language channels, channel routing and interlocks. In operator-controlled systems, the desk is used in combination with DCN dedicated software (the Simultaneous Interpretation module LBB 3572) to form a completely integrated interpretation network.

Wired or wireless language distribution

DCN offers a choice of language distribution systems. Language distribution can be carried out using the DCN system cabling, and languages are accessed and selected by means of channel selector units or delegate units with built-in channel selection facilities. There is also a wireless, infra-red system, where the languages are distributed throughout the conference venue by infra-red transmitters and radiators, and accessed by means of personal infra-red receivers with headphones.



Digital Congress Network

Central Control Equipment



Central control equipment

The Central Control Unit (CCU) forms the heart of the congress management system. The CCU can operate stand-alone to provide automatic conference control, or be accessed by an operator via a PC when more extensive management is required.

All CCUs can control up to 240 contribution units, such as delegate and chairman units, interpreter desks and audio interface units. If more capacity is required, Multi-CCUs can be connected, each of which increases the system capacity by 240 contribution units. CCUs can power a number of contribution units. The maximum number depends on the type of CCU, and the type of contribution units used in the application.

Fully-automatic conference proceedings

The basic CCU does not require operator control, and automatically manages conference proceedings. It offers basic microphone management, simultaneous inter-

pretation and electronic voting facilities, as well as 15 Hi-Q digital audio channels, ten data channels and four communication channels. This allows effective unsupervised control of even large, international conferences.

Operator control via a PC

The extended CCU offers all the facilities of the basic model, but also allows operator control via a PC. The user can access the extensive family of DCN software modules, each with a specific function in controlling and monitoring conferences.

This includes advanced simultaneous interpretation and microphone management, message generation and display, six kinds of voting, intercom, creating a delegate database, attendance registration. In the event of PC failure this CCU will revert to a default operation mode, identical to that of the basic CCU, thus enabling conference proceedings to continue.



Digital Congress Network

Application Software



Microphone Management

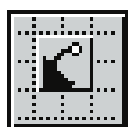

Synoptic Microphone Control

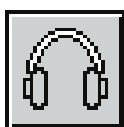

Simultaneous Interpretation

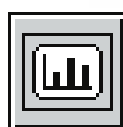

Video Display



ID-Card Encoding



Delegate Database

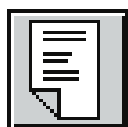

Message Distribution



Text/Status Display

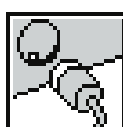

System Installation

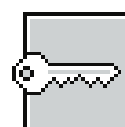

Startup



Parliamentary Voting

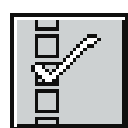

Multi Voting

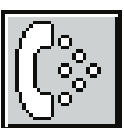

Intercom

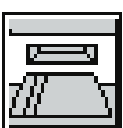

Attendance Registration and Access Control



Camera Control

Application software

A comprehensive range of software modules is available for use with PC-controlled DCN systems. These modules run in Microsoft Windows, and integrate conference preparation, management and control into this versatile graphical computer environment. Any combination of modules can be loaded according to specific system requirements. This software is generally used in larger scale systems where operator control is required.

The PC running the software is connected to the DCN system and therefore has direct links with contribution, interpretation and control equipment via the network cabling. Thus all aspects of conference management can be brought to a single point of control, which leads to ease of use, efficiency and data distribution.

Running DCN software under Windows

Windows permits more than one application to be run at a time and information transfer between applications is possible. As many DCN software modules interact with each other and rely on shared data, the multi-tasking aspect of Windows is an important feature.

The Windows graphical user interface is also highly visual, and the DCN software also makes full use of this capability to control conferences. DCN elements such as contribution units are represented by icons, and these can be arranged and controlled easily using a mouse. Information such as channel/language assignment and voting results is shown using clear graphical displays rather than just lines of text.

There is a DCN software module to cover virtually every imaginable conference requirement. The range includes:

- Microphone Management
- Synoptic Microphone Control
- System Installation
- Parliamentary Voting
- Multi Voting
- Delegate Database
- Simultaneous Interpretation
- Text/Status Display
- Attendance Registration
- ID-Card Encoding
- Message Distribution
- Intercom
- Video Display
- Camera Control
- Open Interface

There is also a Multi-CCU control software package, which runs under OS/2 and allows control of systems using more than one CCU.

Digital Congress Network

Information Distribution Equipment

Information distribution equipment

A major strength of the DCN system is its ability to distribute information to conference participants quickly, efficiently, and to suit all requirements. A wide range of display media are supported, from simple LCD personal screens to video equipment for venue broadcasting.

The Concentus chairman unit and one of the Concentus delegate units are equipped with a graphic LCD screen which displays delegate information, voting time, public and personal messages, microphone status and multi-lingual user instructions. These screens can display languages such as Chinese that use non-European characters. Interpreter desks are equipped with backlit LCD screens.

Hall displays

Hall displays are the ideal medium for quick and effective information distribution to a large number of conference participants. Numeric, alphanumeric or geographic displays are available, mainly for showing voting results. TV receivers can also be used. LCD and CRT video projectors offer high resolution information distribution.

All systems allow high quality display of any live or recorded video material, computer-generated graphics and text, and information generated by DCN software.

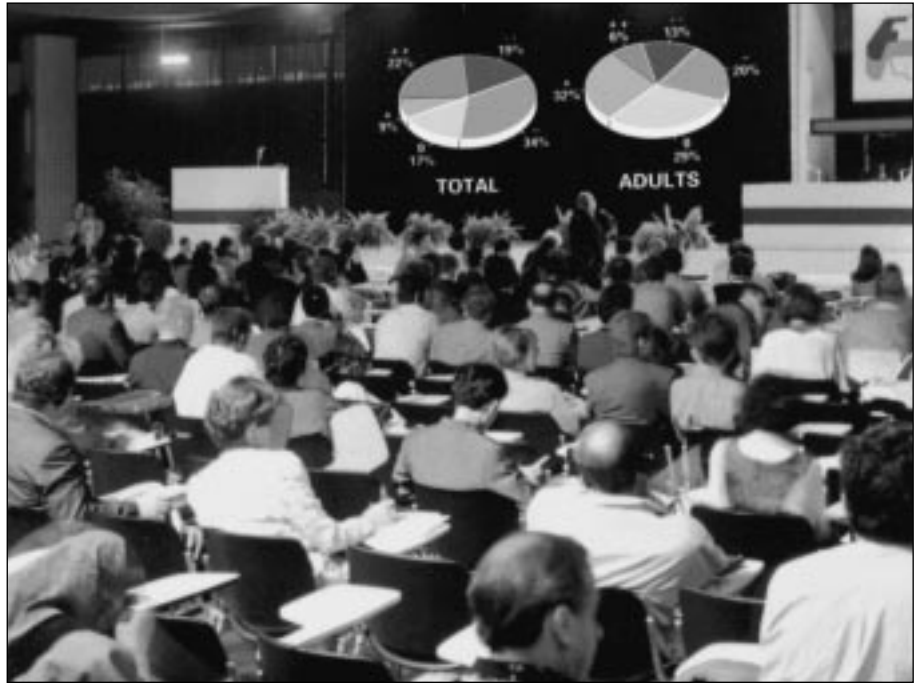

Digital Congress Network

Examples

DCN - the versatile and flexible congress system

To demonstrate the versatility and flexibility of the DCN, five examples of various types of gatherings and conferences are given on the following pages. These examples show the broad spectrum of application possibilities available with DCN, from informal gatherings with

relatively few delegates and no special requirements, through medium-sized conferences which require microphone control and facilities such as voting and interpretations, up to major congresses where a considerable amount of hardware and software support is required, multi-language facilities have to be provided, and operator control via a PC is essential.

In all examples, the basic principle of conference control remains the same, it is only the scale of the network which changes. The modular construction of DCN allows this kind of adjustment and expansion to take place easily and quickly, and without high extra costs; more delegate units are connected to cater for extra delegates, extra functions are provided by adding additional software.

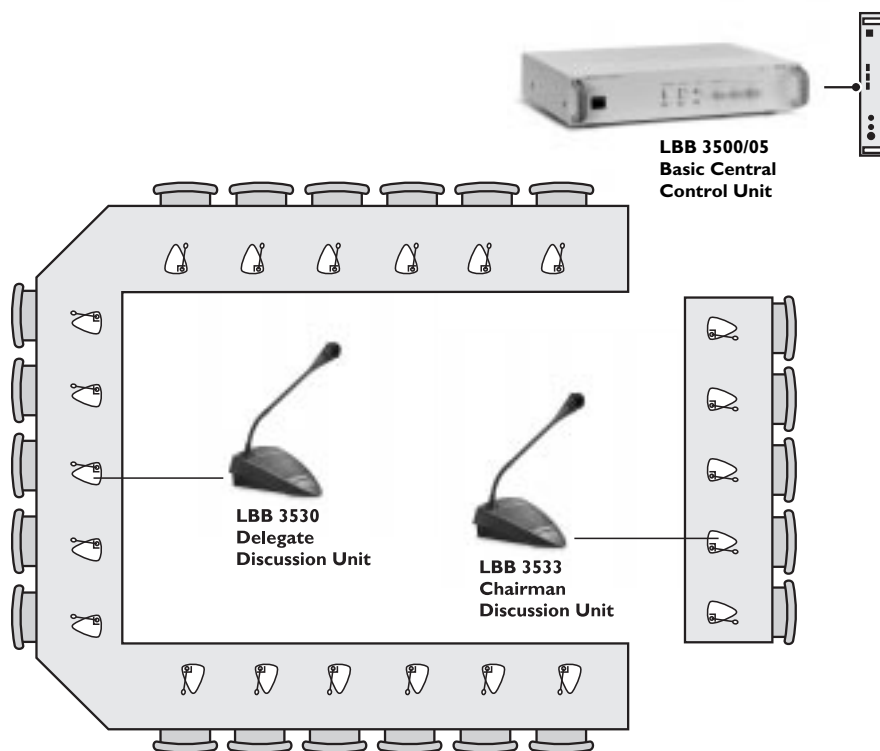

Example 1 - basic discussion system

This is a straightforward situation, where a discussion requires the order and convenience of DCN but only the most basic of hardware. All delegates speak the same language, so there is no need for interpretation. Subsequently no headphones are required, as all delegates receive the same audio signal (the speaker), which is transmitted via loudspeakers.

Each delegate has exactly the same status, and is provided with the same equipment; an LBB 3530/00 Standard Delegate Discussion Unit. The chairman has a LBB 3533/00 Chairman Discussion Unit which allows him or her to override all other delegates. This allows them to speak, listen to the speaker and register a request to speak.

All contribution equipment is connected to the LBB 3500/05 Basic Central Control Unit. This CCU supplies power to all delegate units, provides audio equalisation for all delegate loudspeakers, and is used to determine the microphone operating mode. No operator is required.

Digital Congress Network

Examples

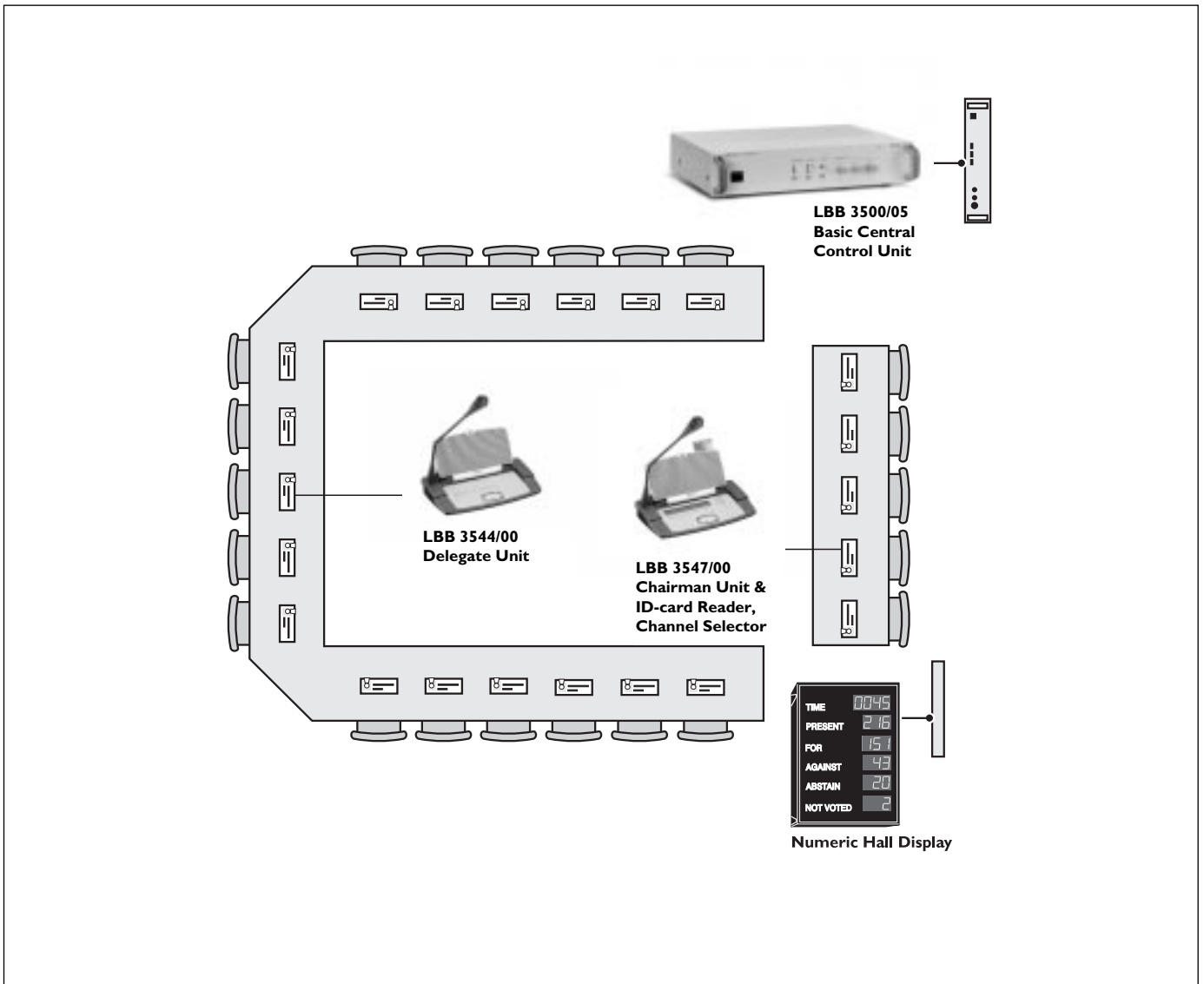

Example 2 - discussion with voting

The kind of discussion shown in this example is typical of a local council or board meeting, where some formalised structure is required and the need for quick and efficient decision taking means that an automatic voting system is required. The Basic CCU, the LBB 3500/05, is used as a stand-alone conference control system, providing voting facilities as well as microphone

management and power for all contribution units. A chairman will preside over the meeting and control the proceedings. An LBB 3547/00 Chairman Unit is provided, whose graphic LCD display provides the chairman with speaker information, voting results and a description of the unit softkey functions. The unit also has microphone priority and can be used to start, stop and suspend voting, and alter delegate microphone status.

Each delegate is equipped with an LBB 3544/00; a table-top delegate unit which allows them to speak, register a request-to-speak, listen to the speaker, and vote. The five voting buttons allow parliamentary-, multiple choice- or audience response voting to take place. The voting results are sent via the CCU to a numeric hall display.

Digital Congress Network

Examples

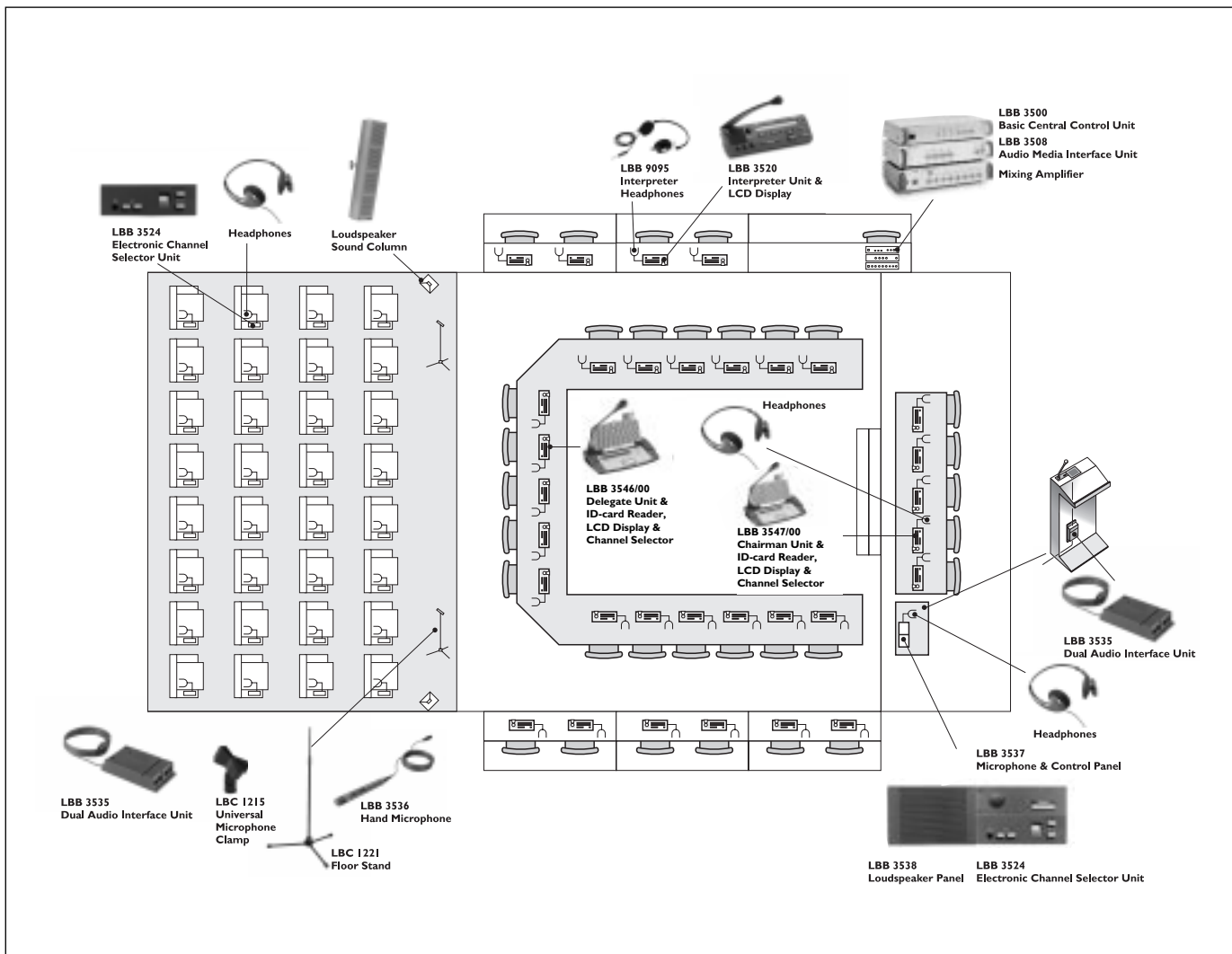

Example 3 - conference with interpretation

This is a situation typical of a small-scale international conference, where a number of different countries are represented and there is no common language. The number of delegates is greater than in example 2, and extra facilities such as simultaneous interpretation and individual information display have to be provided. All of this can still be comfortably managed by an LBB 3500/05 Basic CCU, so no system operator is necessary. Additional central control equipment consists of an LBB 3508/00 Audio Media Interface and Power Supply Unit which enables external analogue equipment (i.e. for broadcasting or recording) to be connected to the DCN, and an amplifier to provide a public address facility to delegates.

A rostrum for guest speakers is equipped with a flush-mounted microphone, loudspeaker, channel selector and headphones. All contributing delegates present are provided with a LBB 3546/00 Delegate Unit with Chip-Card Reader, graphic LCD Screen and Channel Selector, and lightweight headphones. This allows delegates to speak, vote, select the language of their choice and listen to it through the headphones. There is one chairman controlling the conference proceedings, using an LBB 3547/00 Chairman Unit. Additional equipment includes hall loudspeakers and two Hand-Held Microphones with Floor Stands (LBB 3536/00 and LBC 1221/01 respectively), connected to the DCN by means of LBB 3535/00 Dual Audio Interface Units.

The interpreters are located in a booth and equipped with LBB 3520/10 Interpreter Units with backlit LCD Display and Interpreter Headphones (LBB 9095/30). Delegates can select which channel they wish to hear through their headphones by means of a channel selector switch on their delegate units.

Other people present at the conference in a non-contributing role can also listen to any of the interpretations through headphones and via the LBB 3524/xx Electronic Channel Selector Panel, built-in to the chair armrests. This unit is purely for listening purposes, and has no microphone or voting facilities.

Digital Congress Network

Examples

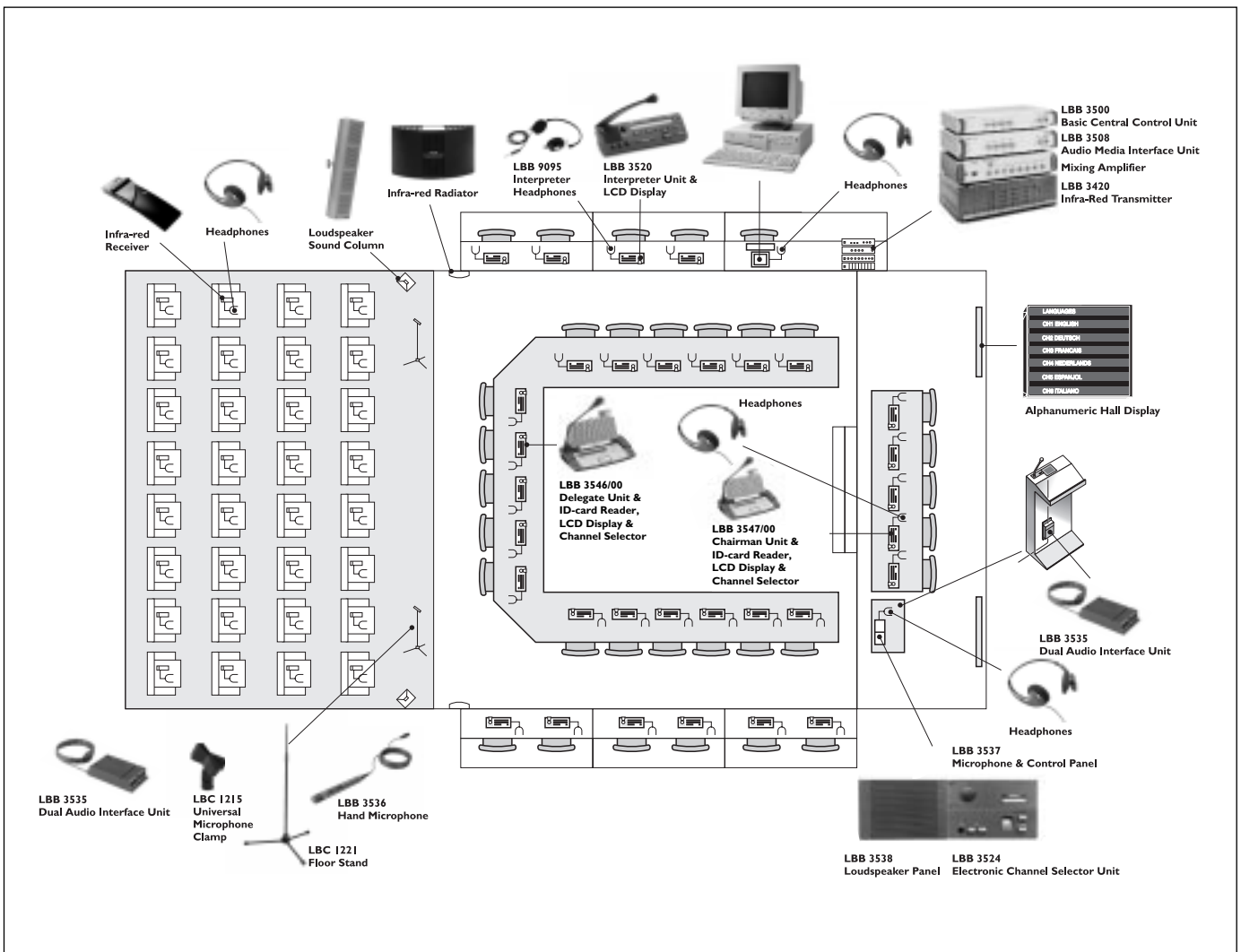

Example 4 - conference with PC control

The venue and number of participants is similar to example 3, but extra facilities are provided by the addition of a PC (with DCN application software modules), a wireless language distribution system and an alphanumeric display for showing voting results. The LBB 3500/15 Extended CCU carries out core control functions, and this is complemented by the conference management facilities available to the operator via the appropriate application software.

The use of the PC and the relevant software modules allows electronic identification and access control for contributing delegates, via a card reader with or without PIN code. All contributing delegates use the LBB 3546/00 Delegate Unit, which incorporates a Chip-Card reader facility. The chip-cards are encoded using the Chip-Card Encoder software module and the LBB 3557 Chip-Card Encoder.

An infra-red transmission system is used to distribute the interpretation languages to the seated non-contributing delegates. The Infra-Red Transmitter and strategically-located infra-red radiators are used to distribute the available languages throughout the conference venue. Each non-contributing delegate is equipped with an infra-red receiver and headphones, and can select the language of his/her choice by means of a channel selection facility on the receiver.

The software modules running on the system PC would typically include the following:

- Startup - essential in all DCN software driven applications
- System Installation - to provide configuration information for other software modules

- Microphone Management or Synoptic Microphone Control - to configure and control delegate microphone status and determine microphone operating mode. Both give on-screen status
- Delegate Database - to compile a database on conference participants and specify conference-related parameters such as access requirements
- Multi Voting - to allow different kinds of voting including parliamentary voting
- Simultaneous Interpretation - to provide up to 15 simultaneous interpretations of the floor language
- Attendance Registration - to provide electronic access control and a means of delegate registration
- Message Distribution - to allow the generation of messages to individuals or groups
- ID-Card Encoder

Digital Congress Network

Examples

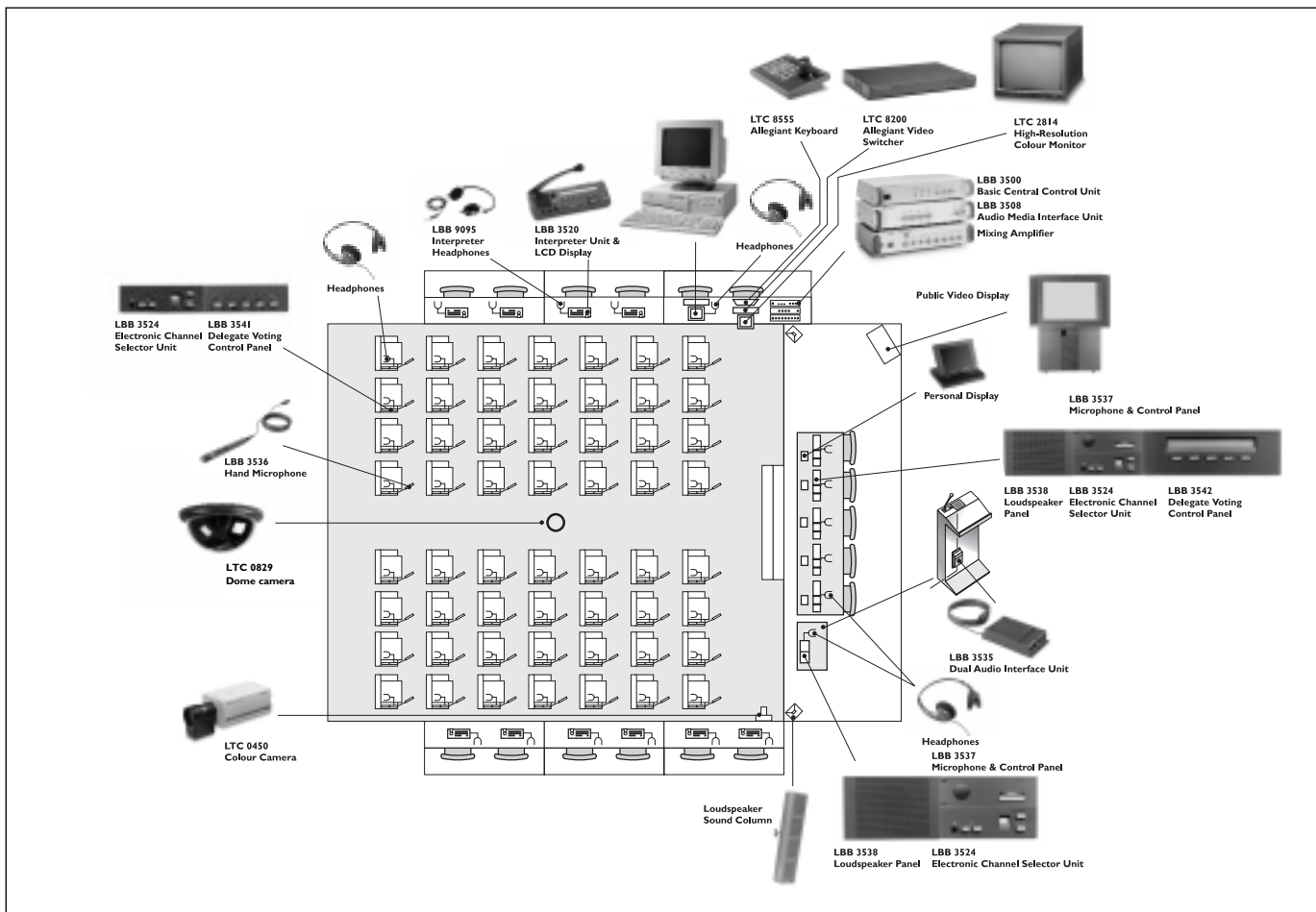

Example 5 - large-scale international conference

A typical example of a large-scale, high-end international conference with many contributing delegates, a chairman and the need for multiple languages. The venue is an auditorium with theatre-style seating and a podium for the chairman, board and guest speakers.

Each participant on the podium is equipped with a personal colour liquid crystal TV, flush-mounted microphone unit, channel selector unit, voting control panel with LCD screen, loudspeaker panel and headphones. Each delegate is provided with a channel selector unit, voting control panel, headphones and hand-held microphone, all of which are built-in to the arm rest of the seat. The headphones allow each participant to listen to the interpretation of their choice, selected using the LBB 3524/xx Electronic Channel Selector Panel. These interpretations are generated by interpreters in the five interpretation booths, and the distribution of the interpretations is monitored by the Simultaneous Interpretation software module running on the system PC.

The LBB 3500/15 CCU is used in conjunction with an LBB 3508/00 Audio Media Interface and Power Supply Unit, which enables external analogue equipment (i.e. for broadcasting or recording) to be connected to the DCN. In addition, an amplifier is connected to provide a sound reinforcement facility for conference delegates.

To enable visual monitoring of the proceedings, control signals generated by the Synoptic Microphone Control and Microphone Management DCN software modules are used by the Camera Control Software and the LTC 8200 Allegiant Video Switcher to activate an LTC 0829 dome camera, which moves and captures the speaking delegate. The image can be displayed on large audience displays such as a Vidiwall, as well as TVs, other monitors and projection screens. The LTC 0450/51 colour camera gives a fixed-position overview of the conference venue. With up to 16 camera inputs on the Allegiant Video Switcher, it is easy to cover every delegate position in the hall.

Additional equipment includes loudspeakers and a public video display for showing voting results (in alphanumeric and graphic form), messages (such as channel/language configuration) and microphone information. A rostrum for guest speakers is equipped with flush-mounted microphone, loudspeaker, channel selector and headphones.

The software modules running on the system PC would typically include:

- Microphone Management or Synoptic Microphone Control - to configure and control delegate microphone status, determine microphone operating mode, and generate control signals for the Allegiant Video Switcher
- Video Display - to allow video-oriented displays to show conference-related information
- Startup
- System Installation
- Delegate Database
- Simultaneous Interpretation
- Multi Voting
- Message Distribution
- Attendance Registration
- ID-Card Encoder
- Camera Control

Overview

Introduction

DCN contribution units are available in table-top or flush-mounting configurations. This section starts with table-top units and accessories. Information on flush-mounting units begins on page 2.14.

Table-top units

There are two types of table-top contribution units; DCN Concentus units and discussion units. Concentus units are typically used for larger congresses and conferences, whereas discussion units are more tailored for smaller gatherings and meetings. Discussion units have their own distinctive styling and are slightly smaller than conference units. They do not have graphic displays, voting, access registration or intercom facilities, but otherwise offer the same high level of functionality and digital convenience as Concentus units.

DCN table-top contribution units are ideal when a flexible system configuration or portable conference facilities are required. All units can be easily plugged into or removed from the system cabling, which leads to quick and efficient setting up of the conference system. DCN Concentus units can also be flush-mounted for convenience in more permanent installations. The Concentus units have a convenient pluggable microphone (supplied separately) available in standard stem length and extended stem length versions. All the contribution units have flexible microphone stems for ease of use. The units can be free-standing or fixed using mounting screws. Storage and transport is further simplified by special rugged suitcases that can accommodate complete DCN systems.

The units can be connected in a simple, economical daisy chain configuration. Alternatively, they can be connected using a single thin cable (and trunk splitter). This 'clean' configuration is especially advantageous for TV coverage, where the backs of the units are on show.

Table-top contribution units range from standard delegate units to delegate units with chip-card reader, graphic LCD screen and channel selector, up to chairman units with a priority key and advanced softkey options. All Concentus units also provide voting facilities, which allow contributing delegates to take part in the decision making process, a vital aspect of modern conferencing.

DCN contribution equipment

Table-top Concentus units (with uni-directional, flexible microphone and built-in loudspeaker) and accessories							
	Voting buttons	LCD display	Channel selector	Chip-card reader	Headphone/headset volume control	Comments/description	Page:
LBB 3544/00	•					Standard delegate unit	2.3
LBB 3545/00	•		•		•	Delegate unit with channel selector	2.4
LBB 3546/00	•	•	•	•	•	Delegate unit with graphic LCD and chip-card reader	2.5
LBB 3547/00	•	•	•	•	•	Chairman unit with graphic LCD and chip-card reader	2.6
LBB 3555/00						Intercom handset and cradle	2.7
LBB 3549/00						Pluggable microphone (standard stem)	2.3
LBB 3549/50						Pluggable microphone (extended stem)	2.3
Table-top discussion units (with uni-directional, flexible stem microphone and built-in loudspeaker) and accessories							
	Voting buttons	LCD display	Channel selector	Chip-card reader	Headphone Volume control*	Comments/description	Page:
LBB 3530/00					•	Standard delegate discussion unit	2.8
LBB 3530/50					•	Long microphone stem version of LBB 3530/00	2.8
LBB 3531/00			•		•	Delegate unit with channel selector	2.9
LBB 3531/50			•		•	Long microphone stem version of LBB 3531/00	2.9
LBB 3533/00					•	Chairman unit	2.10
LBB 3533/50					•	Long microphone stem version of LBB 3533/00	2.10
LBB 3534/00			•		•	Chairman unit with channel selector	2.11
LBB 3534/50			•		•	Long microphone stem version of LBB 3534/00	2.11

* All discussion units are equipped with two headphone sockets and one volume control. They have no headset connection.

Digital Congress Network

Overview

Flush-mounted panels and connection units						
	Mic. button	Voting buttons	LCD display	Chip-card reader	Comments/description	Page:
LBB 3527/00					Table-top housing for LBB 3538/00 or two flush-mounted units	2.22
LBB 3535/00					Dual audio interface unit	2.15
LBB 3536/00	•				Hand-held microphone	2.16
LBB 3536/10	•				Hand-held microphone with coiled cable	2.16
LBB 3537/00	•				Microphone with control panel	2.17
LBB 3537/10	•				Chairman priority control panel	2.18
LBB 3537/50	•				Microphone with extended stem length and control panel	2.17
LBB 3537/20	•				Microphone Control Panel	2.17
LBB 3549/00					Pluggable microphone	2.18
LBB 3549/50					Pluggable microphone with extended stem length	2.18
LBB 3538/00					Loudspeaker panel	2.19
LBB 3540/15					Multi-purpose connection unit	2.19
LBB 3541/00		•			Delegate voting control panel	2.20
LBB 3542/00		•	•		Delegate/chairman voting panel with display	2.21
LBB 3542/20					Delegate/chairman voting panel with cyrillic display	2.21
LBB 3543/15				•	Chip-card reader panel	2.22
LBB 3539/00					Blanking panel	2.22
Microphones and accessories						
					Comments/description	Page:
LBB 9510/20					Hand-held microphone	2.23
LBB 9514/20					Gooseneck microphone	2.23
LBB 9526/10					Lavalier microphone	2.23
LBC 1215/01					Universal microphone clamp	2.24
LBC 1221/01					Floor stand	2.24
LBC 1226/01					Adjustable boom	2.24
LBB 4002/00					Profecta acoustic feedback suppressor	2.24
VMS 2700					Multi-channel wireless microphone system	2.24
Suitcases						
					Comments/description	Page:
Audipack type 6399					Suitcase for Interpreter Units	2.12
Audipack type 6400					Suitcase for Interpreter Units and CCU	2.12
Audipack type 12759					Suitcase for DCN Cententus Units and microphones	2.13
LBB 3312/00					Suitcase for DCN Discussion Units	2.12
LBB 3504/00					Suitcase for Central Control Units	2.13

Table-Top Concentus Units

LBB 3544/00

Standard Delegate Unit

- Compact, attractive delegate unit
- Built-in fold-away flat-panel loudspeaker
- Five voting buttons
- Cable connections located underneath the unit

The LBB 3544/00 is the standard delegate conference unit, enabling delegates to speak, register a request-to-speak, register a response request, listen to the speaker and vote. The flat-panel loudspeaker offers superior acoustics with minimal feedback, so increasing intelligibility. It is automatically muted when the microphone is activated. When the unit is not being used, the loudspeaker panel conveniently folds down. There are five voting buttons for parliamentary-, multiple choice- or audience response voting.

Microphones LBB 3549/00 and LBB 3549/50

This innovative, stylish and ergonomically-designed unit is equipped with a socket for a microphone (ordered separately) with an adjustable stem which simply plugs directly into the delegate unit for added convenience. The microphone has a unidirectional response for optimum performance even in noisy conditions, and includes a red indicator ring which illuminates when the microphone is on. Two microphones are available, with standard and extended stem lengths respectively.

Note: The microphones are separate type numbers, and must be ordered separately.

Controls and indicators

- Socket for pluggable condenser microphone (ordered separately) with built-in pop- and windshield, complete with light ring which illuminates when the microphone is on
- Built-in fold-away flat-panel loudspeaker, automatically muted if a microphone is on
- Microphone 'on/off' or 'request-to-speak' button
- Two 'Microphone on' indicators. One is located above the microphone on/off button (dual colour LED for 'request-to-speak' and 'microphone on' indication). The other is located on top of the loudspeaker.
- 'Request-to-speak' confirmation indicator (green LED)
- Five voting buttons with yellow LED confirmation indicators
These can be used to register:
 - PRESENT, NO (-), ABSTAIN (0), YES (+) (parliamentary voting)
 - Numerals: 1 to 5 (multiple choice or opinion polls)
 - Rating scale: --, -, 0, +, ++ (audience response)
- 'De-init' switch on the underside of the unit

Connections

- 2 m (78.74 in) cable terminated in a moulded 6-pole circular connector
- 6-pole circular connector for loop-through connections
- 6-pole modular jack connector for Intercom Handset LBB 3555/00

Technical data for LBB 3544/00

Mounting	table-top (portable or fixed mounting) and flush-mounting	
Dimensions (H x W x D)	Table-top	50 x 275 x 155 mm (2.0 x 10.8 x 6.1 in)
	Flush-mounted	30 x 275 x 155 mm (1.2 x 10.8 x 6.1 in)
Weight	approx. 1.4 kg (3.1 lb)	
Colour	charcoal base (PH 10736) with silver panel	

Technical data for microphones (LBB 3549/00 and LBB 3549/50)

Mounting	5-pole XLR connector	
Stem length	LBB 3549/00	310 mm (12.2 in)
	LBB 3549/50	480 mm (18.9 in)
Weight	LBB 3549/00	approx. 110 g (0.2 lb)
	LBB 3549/50	approx. 125 g (0.3 lb)
Colour	charcoal (PH 10736)	



Digital Congress Network

Table-Top Concentus Units

LBB 3545/00

Delegate Unit with Channel Selector

- Channel selector for accessing interpretations
- 2-digit channel indicator display with backlighting
- Two headphone sockets, and one external microphone/headset microphone socket
- Two volume controls (left and right)
- Incorporates all functions of LBB 3544/00 Standard Delegate Unit

The LBB 3545/00 is stylistically and functionally similar to the LBB 3544/00 Standard Delegate Unit, but includes a built-in language channel selector. This makes it suitable for conferences where more than one language is used and simultaneous interpretations are available. The channel selector includes up and down select keys and a 2-digit display with backlighting, enabling rapid selection of the required language channel. Channel selection is automatically limited to the number of language channels available. The flat-panel loudspeaker offers superior acoustics with minimal feedback, so increasing intelligibility. When the unit is not being used, the loudspeaker panel conveniently folds down.

Note: The loudspeaker is not muted when the headphones/headset are connected.

Note: The pluggable microphone is automatically switched off when an external microphone is connected.

Note: For information about the pluggable microphones available for use with this unit, please refer to page 2.3.

Controls and indicators

- Channel selector with channel number display with backlighting and channel select keys (up/down)
- Headphone socket and volume control on each side of the unit
- Socket for external microphone or headset microphone
- Socket for pluggable condenser microphone (ordered separately) with built-in pop- and windshield, complete with a light ring which illuminates when the microphone is on.
- Built-in fold-away flat-panel loudspeaker
- Microphone on/off or request-to-speak button
- Two 'Microphone on' indicators. One is located above the microphone on/off button (dual colour LED for 'request-to-speak' and a 'microphone on' indication). The other is located on top of the loudspeaker.
- 'Request-to-speak' confirmation indicator (green LED)
- Five voting buttons with confirmation indicators (yellow LEDs)
These can be used to register:
 - PRESENT, NO (-), ABSTAIN (0), YES (+) (parliamentary voting)
 - Numerals: 1 to 5 (multiple choice or opinion polls)
 - Rating scale: --, -, 0, +, ++ (audience response)
- 'De-init' switch on the underside of the unit

Connections

- 2 m (78.74 m) cable terminated in a moulded 6-pole circular connector
- 6-pole circular connector for loop-through connections
- 6-pole modular jack connector for Intercom Handset LBB 3555/00
- Left and right headphones sockets (3.5 mm (0.14 in) stereo jack type)
- Connection for external microphone or headset microphone (3.5 mm (0.14 in) stereo jack type).



Technical data

Mounting	table-top (portable or fixed mounting) and flush-mounting	
Dimensions (H x W x D)	Table-top	50 x 275 x 155 mm (2.0 x 10.8 x 6.1 in)
	Flush-mounted	30 x 275 x 155 mm (1.2 x 10.8 x 6.1 in)
Weight	approx. 1.4 kg (3.1 lb)	
Colour	charcoal base (PH 10736) with silver panel	

Table-Top Concentus Units

LBB 3546/00

Delegate Unit with Channel Selector, Chip-Card Reader and Graphic LCD Screen

- Graphic LCD screen with backlighting
- Chip-card reader
- Channel selector for accessing interpretations
- Displays messages and conference-related data
- Incorporates all functions of LBB 3545/00 Delegate Unit with Channel Selector

This top-of-the-range, multi-functional delegate unit meets the demands of even the largest conferences. It provides facilities for speaking, registering a request to speak, registering a request to respond, listening, voting, selecting language channels, chip-card reading and displaying conference and user-related information. It is stylistically and functionally similar to the LBB 3545/00 Delegate Unit with Channel Selector, but also includes a chip-card reader and a graphic display with backlighting. When a chip-card is inserted into the card reader, the graphic LCD screen automatically displays user-related information in the language assigned to the delegate chip-card. The graphic LCD screen has permanent backlighting, and can display characters from complex European languages or icon-based scripts such as Chinese. Channel selection is automatically limited to the number of language channels available. The flat-panel loudspeaker offers superior acoustics with minimal feedback, so increasing intelligibility. When the unit is not being used, the loudspeaker panel conveniently folds down.

Note: The loudspeaker is not muted when the headphones/headset are connected.

Note: The pluggable microphone is automatically switched off when an external microphone is connected.

Note: For information about the pluggable microphones available for use with this unit, please refer to page 2.3.

Controls and indicators

- Channel selector with channel number display with backlighting and channel select keys (up/down)
- Headphone socket and volume control on each side of the unit
- Socket for external microphone or headset microphone
- Graphic LCD screen. Typical displays include:
 - softkey description
 - multi-lingual user instructions
 - information on the number of current speakers
 - request-to-speak information and confirmation
 - voting results
 - remaining/elapsed speech time
 - public and personal messages
 - additional user information
- Five softkeys with LED indicators (for use in combination with the graphic LCD screen). The softkeys can provide users with display information such as messages, conference- and microphone user-related information. Depending on the application software the five softkeys can be used as voting buttons with confirmation indicators (yellow LEDs), enabling the user to register:
 - PRESENT, NO (-), ABSTAIN (0), YES (+) (parliamentary voting)
 - Numerals: 1 to 5 (multiple choice or opinion poll voting)
 - Rating scale: - -, - 0, +, ++ (audience response)
- Identification and access control by card reader with or without PIN
- Socket for pluggable condenser microphone (ordered separately) with built-in pop- and windshield, complete with a light ring which illuminates when the microphone is on.
- Built-in fold-away flat-panel loudspeaker
- Microphone on/off or request-to-speak button
- Two 'Microphone on' indicators. One is located above the microphone on/off button (dual colour LED for 'request-to-speak' and 'microphone on' indication). The other is located on top of the loudspeaker.
- 'Request-to-speak' confirmation indicator (green LED)
- 'De-init' switch on the underside of the unit

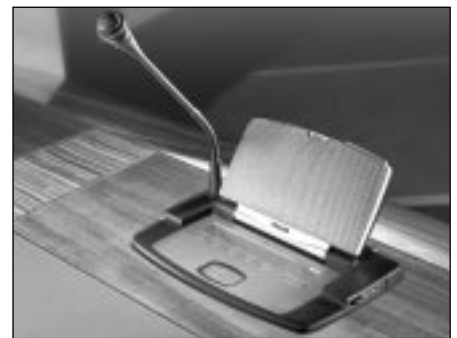

Digital Congress Network

Table-Top Concentus Units

Connections

- 2 m (78.74 in) cable terminated in a moulded 6-pole circular connector
- 6-pole circular connector for loop-through connections
- 6-pole modular jack connector for Intercom LBB 3555/00
- Left and right headphones sockets (3.5 mm (0.14 in) stereo jack type)
- Connection for external microphone or headset microphone (3.5 mm (0.14 in) stereo jack type)

Technical data

Mounting	table-top (portable or fixed mounting) and flush-mounting	
Dimensions (H x W x D)	Table-top	50 x 275 x 155 mm (2.0 x 10.8 x 6.1 in)
	Flush-mounted	30 x 275 x 155 mm (1.2 x 10.8 x 6.1 in)
Weight	approx. 1.5 kg (3.3 lb)	
Colour	charcoal base (PH 10736) with silver panel	

LBB 3547/00

Chairman unit with Channel Selector, Chip-Card Reader and Graphic LCD Screen

- Graphic LCD screen with backlighting
- Chip-card reader
- Channel selector for accessing interpretations
- Displays messages and conference-related data
- Incorporates all functions of LBB 3546/00 Delegate Unit

This stylish and ergonomically-designed chairman unit is equipped with all the necessary facilities to enable the user to function as chairman of a conference. Similar in appearance to the LBB 3546/00 Delegate Unit, the LBB 3547/00 Chairman Unit includes a microphone priority button. When pressed, the priority button causes all currently active delegate microphones to be temporarily or permanently switched off, allowing the chairman to take control of the meeting. The chairman unit can also be used to start, stop or suspend voting, cancel requests to speak, turn off all active microphones and recall messages for display. A graphic LCD screen with permanent backlighting can display characters from complex European languages or icon-based scripts such as Chinese. Channel selection is automatically limited to the number of language channels available. The flat-panel loudspeaker offers superior acoustics with minimal feedback, so increasing intelligibility. When the unit is not being used, the loudspeaker panel conveniently folds down.

Note: The loudspeaker is not automatically muted when the microphones are connected.

Note: For information about the pluggable microphones available for use with this unit, please refer to page 2.3.

Controls and indicators

- Channel selector with channel number display with backlighting and channel select keys (up/down)
- Headphone socket and volume control on each side of the unit
- Socket for external microphone or headset microphone
- Graphic LCD screen. Typical displays include:
 - softkey description
 - multi-lingual user instructions
 - information on the number of current speakers
 - request-to-speak information and confirmation
 - voting results
 - remaining/elapsed speech time
 - public and personal messages
 - additional user information



Table-Top Concentus Units

- Five softkeys with LED indicators (for use in combination with the graphic LCD screen). The softkeys can provide users with display information such as messages, conference- and microphone user-related information. Depending on the application software the five softkeys can be used as voting buttons with confirmation indicators (yellow LEDs), enabling the user to register:
 - PRESENT, NO (-), ABSTAIN (0), YES (+) (parliamentary voting)
 - Numerals: 1 to 5 (multiple choice or opinion poll voting)
 - Rating scale: - -, - 0, +, ++ (audience response)
- Identification and access control by card reader with or without PIN
- Socket for pluggable condenser microphone (ordered separately) with built-in pop- and windshield, complete with a light ring which illuminates when the microphone is on
- Built-in fold-away flat-panel loudspeaker
- Microphone on/off or request-to-speak button
- Two 'Microphone on' indicators. One is located above the microphone on/off button (dual colour LED for 'request-to-speak' and 'microphone on' indication). The other is located on top of the loudspeaker.
- Priority key which causes an optional chime tone to sound while temporarily or permanently muting all active delegate units. The chairman microphone remains active as long as the priority button is pressed.
- 'De-init' switch on the underside of the unit

Connections

- 2 m (78.74 in) cable terminated in a moulded 6-pole circular connector
- 6-pole circular connector for loop-through connections
- 6-pole modular jack connector for Intercom LBB 3555/00
- Left and right headphones sockets (3.5 mm (0.14 in) stereo jack type)
- Connection for external microphone or headset microphone (3.5 mm (0.14 in) stereo jack type)

Technical data	
Mounting	table-top (portable or fixed mounting) and flush-mounting
Dimensions (H x W x D)	Table-top 50 x 275 x 155 mm (2.0 x 10.8 x 6.1 in)
	Flush-mounted 30 x 275 x 155 mm (1.2 x 10.8 x 6.1 in)
Weight	approx. 1.5 kg (3.3 lb)
Colour	charcoal base (PH 10736) with silver panel

LBB 3555/00

Intercom Handset and Cradle

- Ideal for intercom applications
- For use with all DCN Concentus units, Multi-purpose Connection Unit and Interpreter desks
- Can be permanently mounted to wall, chair or table-top

Lightweight and compact, this robust and attractively-styled handset and cradle enables private 2-way conversation between conference participants. The handset is hard-wired to the cradle by a coiled cable (0.5 m (19.68 in) coiled, 2 m (78.74 in) uncoiled). The cradle output cable is terminated with a 6-pole RJ connector for connection to Concentus and interpreter units.

When used in permanent installations, the unit is easily mounted to a table-top or wall using the two screw holes in the cradle. In portable systems the handset can be simply attached to an interpreter unit with the aid of the LBB 3556/00 Mounting Plate.

Technical data	
Mounting:	
Permanent installations	table-top or wall-mounted using the 2 screw holes on the cradle
Dimensions (H x W)	53 x 210 mm (2.08 x 8.26 in)
Weight	approx. 250 g (0.55 lb)
Colour	charcoal (PH 10736)



Digital Congress Network

Table-Top Discussion Units

LBB 3530/00

Delegate Discussion Unit

- Compact, attractive delegate discussion unit
- Microphone with flexible stem
- Built-in loudspeaker
- Two headphone sockets

The LBB 3530/00 is the standard delegate discussion unit, enabling participants to speak, register a request to speak, and listen to the speaker. The microphone stem is extremely flexible, so the microphone can be used by delegates sitting on either side of the unit, thus allowing one unit to serve two delegates. The unit also accommodates two separate headphones, so the speaker can be heard clearly even in situations with excessive background noise. This aesthetically-pleasing unit has a built-in loudspeaker which is muted when the microphone is on to prevent acoustic feedback.



Controls and Indicators

- Microphone with light-ring indicator, built-in pop- and windshield, mounted on a flexible stem
- Loudspeaker, automatically muted when microphone is on and /or headphones are connected
- Microphone on/off button
- Microphone on/request-to-speak bi-colour LED indicator (red-microphone on, green-request to speak)
- 6-pole circular socket for loop-through connection to other DCN system units.
- 2 x 3.5 mm (0.14 in) jackplug socket for headphone connection.
- Rotary volume control for headphones
- Recessed microswitch for resetting the units address (de-init). (For more information, please refer to the DCN Installation manual.)
- 2 m (78.74 in) long cable terminated with a 6-pole circular connector for loop-through connection to other system units.
- Cable relief bracket located at rear/under of the unit. Removable for use when feeding the 2 m (78.74 in) long cable through a table-top.

Technical data

Mounting	table-top (portable or fixed mounting)
Dimensions (H x W x D)	63 x 124 x 172 mm (2.5 x 4.9 x 6.8 in) (without microphone. Height is 127 mm (5.0 in) with microphone in horizontal position)
Length of microphone from mounting surface	313 mm (12.3 in)
Weight	0.9 kg (2.0 lb)
Colour	charcoal (PH 10736)

LBB 3530/50

Delegate Discussion Unit with Long Microphone

- Microphone with extra-long, flexible stem
- Compact, attractive delegate discussion unit
- Built-in loudspeaker
- Two headphone sockets

The LBB 3530/50 is stylistically and functionally identical to the LBB 3530/00 standard Delegate Discussion Unit, but has an extra long microphone stem. This is ideal for delegates who wish to stand up when speaking.

Technical data

Identical to LBB 3530/00 Delegate Discussion Unit but with a microphone stem length of 488 mm (19.2 in)



Table-Top Discussion Units

LBB 3531/00

Delegate Discussion Unit with Channel Selector

- Channel selector for accessing interpretations
- 2-digit channel indicator display
- Two headphone sockets
- Incorporates all functions of LBB 3530/00 Delegate Discussion Unit

The LBB 3531/00 is stylistically identical to the LBB 3530/00 standard Delegate Discussion Unit, but also includes a built-in language channel selector. This makes it suitable for discussions where more than one language is used and simultaneous interpretations are available. The channel selector includes up and down select keys and a 2-digit display, enabling rapid selection of the required language channel. Channel selection is automatically limited to the number of language channels available.

Controls and Indicators

- Numeric display (2-digit LCD screen) with 2 x push-button (up/down) for language channel selection
- Microphone with light-ring indicator, built-in pop- and windshield, mounted on a flexible stem
- Loudspeaker, automatically muted when microphone is on and/or headphones are connected
- Microphone on/off button
- Microphone on/request-to-speak bi-colour LED indicator (red-microphone on, green-request to speak)
- 6-pole circular socket for loop-through connection to other DCN system units.
- 2 x 3.5 mm (0.14 in) jackplug socket for headphone connection.
- Rotary volume control for headphones
- Recessed microswitch for resetting the units address (de-init). (For more information, please refer to the DCN installation manual).
- 2 m (78.74 in) long cable terminated with a 6-pole circular connector for loop-through connection to other system units.
- Cable relief bracket located at rear/under of the unit. Removable for use when feeding the 2 m (78.74 in) long cable through a table-top.

Technical data	
Mounting	table-top (portable or fixed mounting)
Dimensions (H x W x D)	63 x 124 x 172 mm (2.5 x 4.9 x 6.8 in) (without microphone. Height is 127 mm (5.0 in) with microphone in horizontal position)
Length of microphone from mounting surface	313 mm (12.3 in)
Weight	0.9 kg (2.0 lb)
Colour	charcoal (PH 10736)

LBB 3531/50

Delegate Discussion Unit with Channel Selector and Long Microphone

- Microphone with extra-long, flexible stem
- Channel selector for accessing interpretations
- 2-digit channel indicator display
- Incorporates all functions of LBB 3531/00 Delegate Discussion Unit with Channel Selector

The LBB 3531/50 is stylistically and functionally identical to the LBB 3531/00 Delegate Discussion Unit with Channel Selector, but has an extra long microphone stem. This is ideal for delegates who wish to stand up when speaking.

Technical data	
Identical to LBB 3531/00 Delegate Discussion Unit with Channel Selector but with a microphone stem length of 488 mm (19.2 in)	



Digital Congress Network

Table-Top Discussion Units

LBB 3533/00

Chairman Discussion Unit

- Priority key for chairman microphone
- Conference control possibilities
- Incorporates all functions of LBB 3531/00 Delegate Discussion Unit
- Microphone with flexible stem

This stylish, compact chairman unit is equipped with facilities that enable the user to function as the chairman of a discussion. Stylistically identical to the LBB 3530/00 Delegate Discussion Unit, the LBB 3533/00 also has a microphone priority button which, when pressed, causes all currently active delegate microphones to be permanently or temporarily switched off, (depending on settings in the CCU) thus allowing the chairman to take control of the meeting.

Controls and Indicators

- Chairman Priority button. When pressed it emits a chime tone (selected in the CCU), overrules/mutes all active microphone units in the system. The chairman unit microphone remains on for as long as the button is pressed (default setting can be changed in the CCU).
- Microphone with light-ring indicator, built-in pop- and windshield, mounted on a flexible stem
- Loudspeaker, automatically muted when microphone is on and/or headphones are connected
- Microphone on/off button
- Microphone on LED indicator (red)
- 6-pole circular socket for loop-through connection to other DCN system units.
- 2 x 3.5 mm (0.14 in) jackplug socket for headphone connection.
- Rotary volume control for headphones
- Recessed microswitch for resetting the units address (de-init). (For more information, please refer to the DCN installation manual).
- 2 m (78.74 in) long cable terminated with a 6-pole circular connector for loop-through connection to other system units.
- Cable relief bracket located at rear/under of the unit. Removable for use when feeding the 2 m (78.74 in) long cable through a table-top.

Technical data

Mounting	table-top (portable or fixed mounting)
Dimensions (H x W x D)	63 x 124 x 172 mm (2.5 x 4.9 x 6.8 in) (without microphone. Height is 127 mm (5.0 in) with microphone in horizontal position)
Length of microphone from mounting surface	313 mm (12.3 in)
Weight	0.9 kg (2.0 lb)
Colour	charcoal (PH 10736)



LBB 3533/50

Chairman Discussion Unit with Long Microphone

- Microphone with extra-long, flexible stem
- Priority key for chairman microphone
- Conference control possibilities
- Incorporates all functions of LBB 3531/00 Delegate Discussion Unit

The LBB 3533/50 is stylistically and functionally identical to the LBB 3533/00 standard Chairman Discussion Unit, but has an extra long microphone stem. This is ideal for delegates who wish to stand up when speaking.

Technical data

Identical to LBB 3533/00 Chairman Discussion Unit but with a microphone stem length of 488 mm (19.2 in)



Table-Top Discussion Units

LBB 3534/00

Chairman Discussion Unit with Channel Selector

- Channel selector for accessing interpretations
- 2-digit channel indicator display
- Two headphone sockets
- Incorporates all functions of LBB 3533/00 Chairman Discussion Unit

The LBB 3534/00 is stylistically identical to the LBB 3533/00 standard Chairman Discussion Unit, but also includes a built-in language channel selector. This makes it suitable for discussions where more than one language is used and simultaneous interpretations are available. The channel selector includes up and down select keys and a 2-digit display, enabling rapid selection of the required language channel. Channel selection is automatically limited to the number of language channels available.

Controls and Indicators

- Numeric display (2-digit LCD screen) with 2 x push-button (up/down) for language channel selection
- Chairman Priority button. When pressed it emits a chime tone (selected in the CCU), overrules/mutes all active microphone units in the system. The chairman unit microphone remains on for as long as the button is pressed (default setting can be changed in the CCU).
- Microphone with light-ring indicator, built-in pop- and windshield, mounted on a flexible stem
- Loudspeaker, automatically muted when microphone is on
- Microphone on/off button
- Microphone on LED indicator (red)
- 6-pole circular socket for loop-through connection to other DCN system units.
- 2 x 3.5 mm (0.14 in) jackplug socket for headphone connection.
- Rotary volume control for headphones
- Recessed microswitch for resetting the units address (de-init). (For more information, please refer to the DCN installation manual).
- 2 m (78.74 in) long cable terminated with a 6-pole circular connector for loop-through connection to other system units.
- Cable relief bracket located at rear/under of the unit. Removable for use when feeding the 2 m (78.74 in) long cable through a table-top.

Technical data	
Mounting	table-top (portable or fixed mounting)
Dimensions (H x W x D)	63 x 124 x 172 mm (2.5 x 4.9 x 6.8 in) (without microphone. Height is 127 mm (5.0 in) with microphone in horizontal position)
Length of microphone from mounting surface	313 mm (12.3 in)
Weight	0.9 kg (2.0 lb)
Colour	charcoal (PH 10736)

LBB 3534/50

Chairman Discussion Unit with Channel Selector and Long Microphone

- Microphone with extra-long, flexible stem
- Channel selector for accessing interpretations
- 2-digit channel indicator display
- Incorporates all functions of LBB 3534/00 Chairman Discussion Unit with Channel Selector

Technical data

Identical to LBB 3534/00 Chairman Discussion Unit with Channel Selector but with a microphone stem length of 488 mm (19.2 in)



Digital Congress Network

Suitcases

LBB 3312/00

Suitcase for DCN Discussion Units

- Can accommodate up to ten discussion units
- Attractive finish, yet sturdy construction
- Simplify packing and unpacking
- Easy to carry and store

This transport and storage suitcase is for use in applications where DCN discussion units will not be used in one fixed location, and therefore has to be easily transportable. This is often the case in town halls, hotels, business centres, local government offices, or smaller halls in major conference venues.

The LBB 3312/00 is designed to accommodate 10 discussion units with standard-length microphones. Any combination of delegate/chairman units can be catered for. The inside of the suitcase has specially moulded packing to accommodate the discussion units, which gives ample protection while making packing and unpacking easier.

The suitcase is attractive but also extremely durable and very practical. It has handles on the top and side, and two wheels on the underside for ease of transportation. There are two separate locks for extra security.



Technical data	
Dimensions (H x W x D)	560 x 795 x 235 mm (22.0 x 31.3 x 9.3 in)
Material:	3 mm (0.1 in) thick ABS
Weight	6 kg (13.2 lb)
Colour	RAL 9004

Audipack type suitcases

The Audipack type suitcases are for use in applications where the DCN will not be used in one fixed location, and therefore has to be easily transportable. This is often the case in hotels, local government authorities or large conference venues with many meeting rooms. The suitcases are rugged and hard wearing, with metal edges, reinforced corner pieces and quick release fasteners. The internal packing is specially shaped to accommodate the various DCN elements, which gives ample protection while making packing and unpacking quick and easy.

Basic Suitcase (Audipack type 6399)

- Rugged construction with reinforced corners
- Simplifies packing and unpacking
- Easy to carry and store

The Basic Suitcase (Type 6399) can hold:

- Five interpreters units
- Central Control Unit LBB 3500 or Audio Media Interface and Power Supply Unit LBB 3508
- Extension cables
- Dual Audio Interface Unit LBB 3535/00
- Hand-held microphone



Technical data	Basic Suitcase
Dimensions (H x W x D)	400 x 660 x 285 mm (15.7 x 26.0 x 11.2 in)
Weight	10.6 kg (23.3 lb)
Colour	dark grey

Suitcases

Extension Suitcase (Audipack type 6400)

- Rugged construction with reinforced corners
- Simplifies packing and unpacking
- Easy to carry and store

If a larger system is required, the Extension Suitcase (Type 6400) can be used. This can hold:

- 10 interpreter units and microphones

Technical data	Extension Suitcase
Dimensions (H x W x D)	400 x 660 x 285 mm (15.7 x 26.0 x 11.2 in)
Weight	9.1 kg (20.0 lb)
Colour	dark grey



Suitcase for Concentus units (Audipack type 12759)

- Rugged construction with reinforced corners
- Simplifies packing and unpacking
- Easy to carry and store

The suitcase for the Concentus units (Type 12759) can accommodate 10 delegate/chairman units. There is also a special cover compartment for housing 10 microphones (both standard and long). It can hold:

- 10 chairman/delegate units and microphones

Technical data	Suitcase for Concentus units
Dimensions (H x W x D)	430 x 665 x 255 mm (16.90 x 26.20 x 10.00 in)
Weight	9.3 kg (20.50 lb)
Colour	dark grey



LBB 3504/00

Suitcase for Central Control Unit LBB 3500/xx

- Can accommodate CCU or Audio Media Interface, plus extension cables
- Attractive finish, yet sturdy construction
- Simplify packing and unpacking
- Easy to carry and store

This transport and storage suitcase is slightly smaller than the LBB 3312/00 Suitcase for DCN Discussion Units, and is designed to accommodate a LBB 3500/xx Central Control Unit or an LBB 3508/00 Audio Media Interface. It also has room for the mains plug for the CCU, plus two LBB 3516/05 Extension Cables (5 m (196.85 in) length) or a single 3516/10 Extension Cable (10 m (393.70 in) length).

Technical data	
Dimensions (H x W x D)	495 x 685 x 225 mm (19.48 x 26.96 x 8.85 in)
Material:	3 mm (0.12 in) thick ABS
Weight	4.95 kg (10.89 lb)
Colour	RAL 9004



Digital Congress Network

Flush-Mounted Units

Flush-mounted contribution equipment

The broad range of DCN flush-mounted equipment is used for creating individual system contribution units for customised solutions. Flush-mounted equipment is ideal for use in permanent installations where portability is not required. It can be installed into either table-tops or seat arm rests.

All functions and facilities of table-top contribution units are also available in flush-mounted versions. As an example, a delegate unit can be created by combining an LBB 3540/15 Multi-Purpose Connection Unit or an LBB 3535/00 Dual Audio Interface Unit - the main components in tailor-made flush-mounted solutions - with a combination of the following elements:

- LBB 3537/00 Control Panel with Microphone
- LBB 3537/20 Pluggable Microphone Control Panel
- LBB 3537/50 Microphone with Extended Stem Length and Control Panel
- LBB 3549/00 Pluggable Microphone
- LBB 3549/50 Pluggable Microphone with Extended Stem
- LBB 3537/10 Chairman Priority Control Panel
- LBB 3536/00 Hand-Held Microphone
- LBB 3536/10 Hand-Held Microphone
- LBB 3538/00 Loudspeaker Panel
- LBB 3541/00 Delegate Voting Control Panel
- LBB 3542/00 Delegate/Chairman Voting Control Panel with LCD Screen

- LBB 3542/20 Delegate/Chairman Voting Control Panel with Cyrillic LCD screen
- LBB 3543/15 Chip-Card Reader Panel
- LBB 3524/00 Electronic Channel Selector Panel
- LBB 3524/10 Electronic Channel Selector Panel
- LBB 3526/10 Electronic Channel Selector Panel with Backlighting
- LBB 3527/00 Table-Top Housing for Loudspeaker LBB 3538/00
- LBB 3555/00 Intercom Handset

All flush-mounted units are available in standard sizes of 40 x 120 mm (1.57 x 4.72 in) with the exception of the LBB 3538/00 Loudspeaker Panel, which is 80 x 120 mm (3.14 x 4.72 in), and the LBB 3542 Delegate/Chairman Voting Control Panel, which is 80 x 240 mm

(3.14 x 9.44 in). The dimensions of these units allow them to be neatly installed and positioned alongside each other in portrait or landscape configurations.

Mounting

These units can be mounted in wood or metal. When mounting into a metal surface, the click-to-fit mechanism available on all flush-mounting units is used to secure the units into cut-outs on table-tops or the arm rests of seats. When mounting into a wooden surface the units are secured by screws. Each unit includes drill guide holes located under the front cover, which are used for guidance when drilling screw holes.

In the example below left, a guest speaker podium is equipped with the LBB 3537/00 Microphone with Control Panel and an LBB 3538/00 Loudspeaker Panel. An LBB 3535/00 Dual Audio Interface Unit is used to connect the microphone and loudspeaker to the DCN system. The Dual Audio Interface Unit can support two such configurations, as shown below in the central example. If additional features such as an LBB 3542/00 Voting Control Panel with LCD Screen are required, an LBB 3540/15 Multi-Purpose Connection Unit can be used, as shown below right.

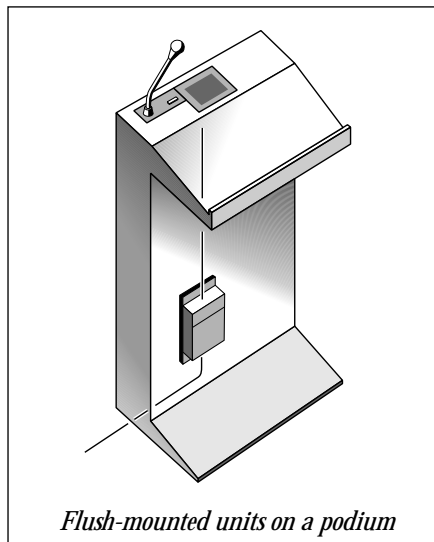

Flush-mounted units on a podium

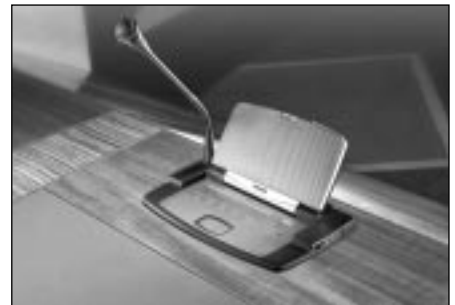

Flush-mounted units for permanent conference facilities

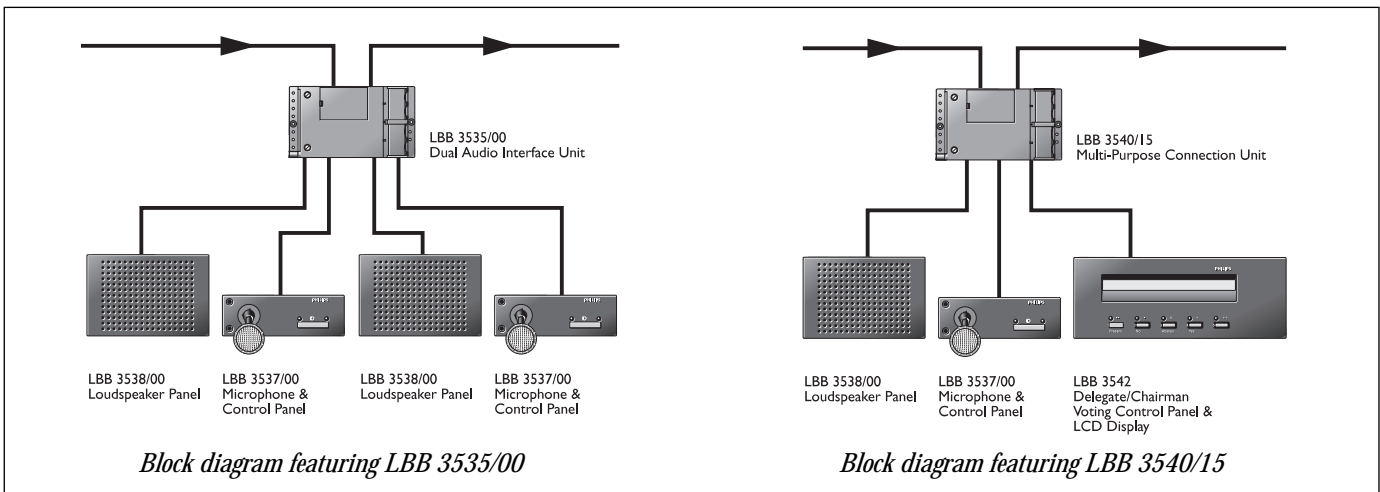

Block diagram featuring LBB 3535/00

Block diagram featuring LBB 3540/15

Flush-Mounted Units

LBB 3535/00

Dual Audio Interface Unit

- Two separate inputs serving two delegate positions
- Accepts both microphone and line inputs
- Outputs to headphones or loudspeakers
- Range of mounting options

The LBB 3535/00 Dual Audio Interface Unit enables various types of microphones, as well as line sources, to be connected to the DCN system. It can also be used to create a chairman position or for an ambient microphone input. An internal switch allows the selection of these options. This unobtrusive, compact unit can be used freestanding on a table-top, mounted to a wall or discreetly mounted into a table-top or chair arm rest.

It is especially suitable for use with the LBB 3536/xx Hand-Held Microphone and the LBB 3537/xx Microphone with Control Panel. Its versatility enables it to accept floor-, podium- or wireless microphones.

The unit includes two separate inputs, each selectable for use with either a microphone or a line input source. Each input can be assigned its own seat number, allowing the LBB 3535/00 to serve two delegate positions.

An internal setting is available when assigning the Dual Audio Interface Unit for use as a delegate unit, chairman unit, or ambient microphone. The ambient microphone is located in the conference venue, and is switched on automatically when no other delegate unit or chairman unit microphones are active. In this way, interpreters always have audio contact with conference venue.

When used to create a chairman position, one microphone input is used for connecting the Chairman Priority Control Panel LBB 3537/10 and the other accepts the input from a DCN microphone such as an LBB 3536/x0, LBB 3537/xx or LBB 3549/xx. The LBB 3549/xx microphones must be used with the LBB 3537/20 Microphone Control Panel.

3.5 mm (0.14 in) stereo jack sockets are provided for connection to headphones or to Loudspeaker Panel LBB 3538/00. The output is switched off when the corresponding input is switched on.

Controls and indicators

- Three Switches per input with the following possibilities:
 - (1) Microphone or line selection
 - (2) Asymmetrical microphone input, symmetrical microphone/line input, or symmetrical microphone input with phantom power selection
 - (3) Input attenuation selection of 0, 6, 12 or 18 dB
- +/- 3 dB input level fine adjustment potentiometer per input

Interconnection

- Two balanced audio inputs for line (0 dB) or microphone (-60 dB) sources with or without a phantom power supply. (2 x 8-pole 262° DIN-type socket)

Note: Only one voice-activated microphone can be connected.

- Remote control inputs (switches) and outputs (LEDs) matching LBB 3536 and LBB 3537 control facilities
- Two loudspeaker or headphone output connectors (3.5 mm (0.14 in) stereo jack socket)
- 2 m (78.74 in) cable terminated with a moulded 6-pole circular connector
- 6-pole circular connector for loop-through system

Technical data	
Mounting	on wall, under table-top or seat, in arm rest or in cable duct
Dimensions (H x W x D)	35 x 100 x 170 mm (1.37 x 3.93 x 6.69 in) (excl. cables)
Weight	500 g (1.10 lb)
Colour	charcoal (PH 10736)



Digital Congress Network

Flush-Mounted Units

LBB 3536/00

Hand-Held Microphone

- Light, portable microphone
- Built-in plop- and windshield
- On/off switch and LED status indicators
- 5 m (196.85 in) cable

The LBB 3536/00 is a uni-directional, condenser microphone with built-in plop- and windshield. It fits comfortably into the hand and is ideal for applications where the speaker is not stationary.

A microphone on/off button and LED indicator lamps are built into the microphone housing. Two of these microphones can be connected to the Dual Audio Interface Unit LBB 3535/00 or to Multi-Purpose Connection Unit LBB 3540/15.

Controls and indicators

- Condenser microphone with built-in plop- and windshield
- Microphone on/off or request-to-speak button
- 'Microphone on' indicator (red LED)
- 'Request-to-speak' confirmation indicator (green LED)

Interconnection

- 5 m (196.85 in) cable terminated with an 8-pole 262° DIN-type plug

Technical data

Mounting	using clamp LBC 1215/01 the microphone may be mounted on a stand, wall or on a chair
Dimensions (H x D)	215 x 30 mm (8.46 x 1.18 in)
Weight	350 g (0.77 lb)
Colour	dark grey (PH 10714)



LBB 3536/10

Hand-Held Microphone with Coiled Cable

- Light, portable microphone
- Built-in plop- and wind shield
- On/off switch and LED status indicators
- Coiled cable

Identical to Hand-Held Microphone LBB 3536/00 but with a coiled connecting cable. (Uncoiled length: 1.4 m (55.11 in); coiled length 0.4 m (15.74 in))

Technical data

Identical to LBB 3536/00



Flush-Mounted Units

LBB 3537/00

Microphone with Control Panel

- Uni-directional microphone on adjustable stem
- Built-in pop- and windshield
- On/off switch and LED status indicators

The LBB 3537/00 is a uni-directional, condenser microphone, mounted on a flush-mounted control panel by means of a flexible stem. The microphone has a built-in pop- and windshield, as well as a light ring indicator which illuminates when the microphone is on. The control panel can be connected to Multi-Purpose Connection Unit LBB 3540/15, or to one input of the Dual Audio Interface Unit LBB 3535/00.



Controls and indicators

- Condenser microphone with built-in pop- and windshield, complete with a light ring which illuminates when the microphone is on
- Microphone on/off or request-to-speak button
- 'Microphone on' indicator (red LED)
- 'Request-to-speak' confirmation indicator (green LED)

Interconnection

- 2 m (78.74 in) cable terminated with 8-pole 262° DIN-type plug

Technical data	
Mounting	click-to-fit in a 2 mm (0.078 in) thick metal panel (secured using 2 screws)
Dimensions (H x W)	front panel 40 x 120 mm (1.57 x 4.72 in) (built-in depth 30 mm (1.18 in)). Microphone stem length 310 mm (12.20 in)
Weight	approx. 200 g (0.44 lb)
Colour	charcoal (PH 10736)

LBB 3537/50

Microphone with Extended Stem Length and Control Panel

- Uni-directional microphone on adjustable stem
- Built-in pop- and windshield
- On/off switch and LED status indicators
- Extended microphone stem length

The LBB 3537/50 is functionally identical to the LBB 3537/00.

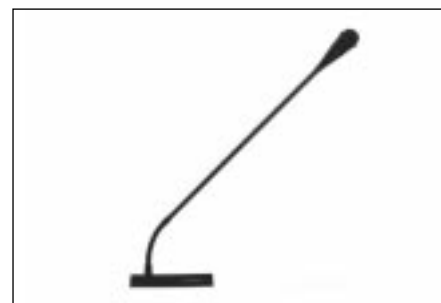

Technical data	
Identical to LBB 3537/00 Microphone with Control Panel but with a microphone stem length of 480 mm (18.89 in). (see page 2.17)	

LBB 3537/20

Pluggable Microphone Control Panel

- On/off switch and LED status indicators
- Microphone can be plugged onto- unplugged from control panel
- Microphones can be removed for microphone positions not in use
- Reduces risk of damage when system is not used

The LBB 3537/20 is used with the LBB 3549/00 and LBB 3549/50 Pluggable Microphones.

Interconnection

- 2 m (78.74 in) cable terminated with 8-pole 262° DIN-type plug

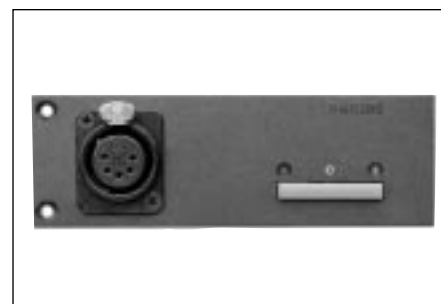

Technical data	
Mounting	click-to-fit in a 2 mm (0.078 in) thick metal panel (secured using 2 screws)
Dimensions (H x W)	front panel 40 x 120 mm (1.57 x 4.72 in) (built-in depth 30 mm (1.18 in)).
Weight	approx. 125 g (0.28 lb)
Colour	charcoal (PH 10736)

Digital Congress Network

Flush-Mounted Units

LBB 3549/00 and LBB 3549/50

Pluggable Microphones

- Uni-directional microphones on adjustable stem
- Built-in pop- and windshield

The LBB 3549/00 is a uni-directional, condenser microphone with an adjustable stem, that plugs into the LBB 3537/20 Microphone Control Panel for quick and convenient use. The LBB 3549/50 is identical to the LBB 3549/00, but has a longer stem length.

Controls and indicators

- Condenser microphones with built-in pop- and windshield, complete with a light ring which illuminates when the microphone is on



Technical data

Mounting	click-to-fit in a 2 mm (0.08 in) thick metal panel (secured using 2 screws)	
Stem length	LBB 3549/00	310 mm (12.2 in)
	LBB 3549/50	480 mm (18.9 in)
Weight	LBB 3549/00	approx. 110 g (0.24 lb)
	LBB 3549/50	approx. 125 g (0.28 lb)
Colour	charcoal (PH 10736)	

LBB 3537/10

Chairman Priority Control Panel

The chairman priority panel incorporates a priority button and an LED indicator. This unit is used in combination with the LBB 3537/00 Microphone with Control Panel to create a chairman position. When the priority button is pressed, all currently active delegate microphones are temporarily switched off, (dependent on CCU setting) thus giving the chairman priority microphone status over other delegates. The chairman priority panel can be connected to Multi-Purpose Connection Unit LBB 3540/15, or to one input of the Dual Audio Interface Unit LBB 3535/00.

Controls and indicators

- 'Microphone on' indicator (red LED)
- Priority key

Interconnection

- 2 m (78.74 in) cable terminated with 8-pole 262° DIN-type plug

Technical data

Mounting	click-to-fit in a 2 mm (0.08 in) thick metal panel (secured using 2 screws)
Dimensions (H x W)	front panel 40 x 120 mm (1.57 x 4.72 in) (built-in depth 30 mm (1.2 in))
Weight	approx. 125 g (0.28 lb)
Colour	charcoal (PH 10736)



Flush-Mounted Units

LBB 3538/00

Loudspeaker Panel

Ideal for flush mounting on table-tops or the rear of seats, this loudspeaker panel is intended for use in combination with the Dual Audio Interface Unit (LBB 3535/00), or the Multi-Purpose Connection Unit (LBB 3540/15). It consists of a loudspeaker behind a rectangular grille. Also included is a 2 m (78.74 in) cable, terminated with a 3.5 mm (0.14 in) stereo jack plug.

Technical data	
Mounting	click-to-fit in a 2 mm (0.08 in) thick metal panel (secured using 2 screws)
Dimensions (H x W)	front panel 80 x 120 mm (3.15 x 4.72 in) or 120 x 80 mm, depending on orientation. (built-in depth 30 mm (1.18 in))
Weight	approx. 200 g (0.44 lb)
Colour	charcoal (PH 10736)

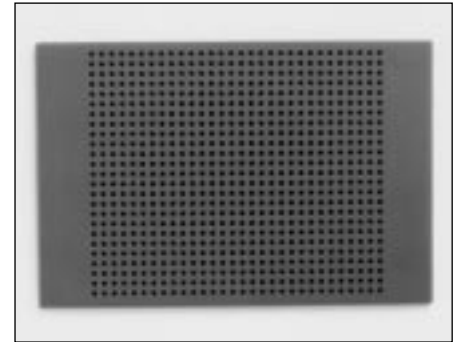

Note: The LBB 3538/00 can be mounted in Table-Top Housing LBB 3527/00.

LBB 3540/15

Multi-Purpose Connection Unit

- Two mixing microphone inputs
- Outputs to headphones or loudspeakers
- Range of mounting options
- Use for entrance/exit registration

The Multi-Purpose Connection Unit is intended for use in flush-mounted tailored solutions. Its versatility enables a number of functions to be added, making it ideal for both chairmen and delegates alike. Such functions include facilities for connecting a Voting Control Panel, with or without an LCD Display (LBB 3541/00 or LBB 3542/00), and an LBB 3543/15 Chip-Card Reader.

In addition, two audio input sockets with phantom supply provide a choice of connecting two microphones, such as those in the condenser or dynamic range. Both audio inputs are mixed together. The unit is especially suited for use with Hand-Held Microphones LBB 3536, Microphone with Control Panel LBB 3537/xx or LBB 3549/xx Pluggable Microphones with LBB 3537/20 Microphone Control Panel. In addition the unit also provides connection for an Intercom Handset LBB 3555/00.

A 3.5 mm (0.14 in) stereo jack socket is provided for connection to headphones or to loudspeaker panel LBB 3538/00. The loudspeaker output is switched off when the units input is switched on. The unit, housed in an ABS case, can be mounted free-standing on a table-top, mounted on a wall, or discreetly mounted into table-tops or into the arm rests of chairs etc.

Controls and indicators

- Two switches are provided for the following:
 - (1) Asymmetrical or Symmetrical microphone input or Symmetrical microphone input with phantom power
 - (2) Attenuation : 0, 6, 12 or 18 dB
- +/- 3 dB input level fine adjustment potentiometer

Note: An internal jumper is available when assigning the multi-purpose connection unit for use as either a delegates unit or a chairman unit. When used as a chairman unit, one input is for microphone (LBB 3537/xx) and the other for priority control (LBB 3537/10).

Another internal setting is available for assigning the LBB 3540/15 as an entrance/exit unit, used in combination with Chip-Card Reader Panel LBB 3543/15 and LCD Display LBB 3542. Software module Attendance Registration LBB 3578 is also required.



Digital Congress Network

Flush-Mounted Units

Interconnection

- 20-pole connector for connection of Delegate Voting Control Panel LBB 3541/00 or FM Delegate/Chairman Voting Control Panel with LCD Display LBB 3542/x0
- 10-pole connector for Chip-Card Reader Panel LBB 3543/15
- 6-pole modular jack connector for Intercom Handset LBB 3555/00
- Two balanced audio inputs for microphones with or without a phantom power supply (2 x 8-pole 262° DIN-type socket)
- Remote control inputs (switches) and outputs (LEDs) matching LBB 3536/00 and LBB 3537/00 control facilities
- Loudspeaker output connector (3.5 mm (0.14 in) stereo jack socket)
- 6-pole circular connector for loop-through system cabling
- 2 m (78.74 in) cable terminated with a moulded 6-pole circular connector

Technical data

Mounting	table-top (free standing), on wall or flush mounting
Dimensions (H x W x D)	35 x 100 x 170 mm (1.37 x 3.93 x 6.69 in) (excl. cables)
Weight	500 g (1.10 lb)
Colour	charcoal (PH 10736)

LBB 3541/00

Delegate Voting Control Panel

- Allows three types of voting
- LED vote confirmation indicators
- Easily mountable

A flush mounting panel with voting facilities, the panel is intended for flush mounting into table-tops or the arm rests of chairs etc. The panel can be connected to the Multi-Purpose Connection Unit LBB 3540/15.

Controls and indicators

- Five voting buttons with yellow LED confirmation indicators. These can be used to register:
 - PRESENT, NO (-), ABSTAIN (0), YES (+) (parliamentary voting)
 - Numerals: 1 to 5 (multiple choice or opinion polls)
 - Rating scale: - -, - 0, +, ++ (audience response)

Interconnection

- 2 m (78.74 in) flat ribbon cable terminated with a 20-pole connector

Technical data

Mounting	click-to-fit in a metal panel with a thickness of 2 mm (0.08 in) (4 screws optional)
Dimensions (H x W)	front panel 40 x 120 mm (1.57 x 4.72 in) (built-in depth approx. 30 mm (1.18 in))
Weight	115 g (0.25 lb)
Colour	charcoal (PH 10736)



Flush-Mounted Units

LBB 3542/00

Delegate/Chairman Voting Control Panel with LCD Screen

- 2-line, 40-character LCD screen
- Displays extra information including messages
- Full range of voting control options
- LED vote confirmation indicators

This flush-mounting panel with voting and other control facilities includes a 2-line, 40-character LCD screen, and has mounting facilities for a Chip-Card Reader LBB 3543/15. The panel is intended for flush mounting into table-tops and can be connected to Multi-Purpose Connection Unit LBB 3540/15.

The LCD screen enables delegates to view valuable conference-related information, general user instructions and text messages.

Controls and indicators

- 2-line, 40-character LCD screen. Typical displays include:
 - softkey description
 - multi-lingual user instructions
 - information on speakers
 - request-to-speak information
 - voting results
 - public and personal messages
 - additional user information
- Five softkeys with yellow LED indicators (for use in combination with the LCD screen). The softkeys can provide users with display information such as messages, conference- and microphone user- related information. Depending on the application software the five softkeys can provide the following functions:

When used for a chairman:

- NO (-), ABSTAIN (0), YES (+) buttons (parliamentary voting) with confirmation indicators (yellow LEDs)
- CANCEL ALL REQUESTS button to clear the request-to-speak list
- START, STOP and HOLD buttons with indicators (yellow LEDs) to control voting sessions
- MESSAGE button to recall the last message on the built-in display

When used for a delegate:

- PRESENT, NO (-), ABSTAIN (0), YES (+) (parliamentary voting)
- Numerals: 1 to 5 (multiple choice or opinion polls)
- Rating scale: - -, - 0, +, ++ (audience response)

Interconnection

- 2 m (78.74 in) flat ribbon cable terminated with a 20-pole connector for LBB 3540/15 Multi-Purpose Connection Unit

Technical data	
Mounting	click-to-fit in a metal panel with a thickness of 2 mm (0.08 in) (4 screws optional)
Dimensions (H x W)	front panel 80 x 240 mm (3.41 x 9.44 in) (built-in depth approx. 30 mm (1.18 in))
Weight	260 g (0.57 lb)
Colour	charcoal (PH 10736)



LBB 3542/20

Delegate/Chairman Voting Control Panel with Cyrillic LCD Screen

This is identical to the LBB 3542/00 unit, but it can display characters from the Cyrillic alphabet on the LCD screen.



Digital Congress Network

Flush-Mounted Units

LBB 3543/15

Chip-Card Reader Panel

The flush-mounted chip-card reader enables electronic identification of delegates to the DCN system as well as providing a convenient facility that ensures only authorised delegates can participate in voting sessions or general conference proceedings such as microphone use. The Chip-Card Reader can be connected to the Multi-Purpose Connection Unit LBB 3540/15.

Controls and indicators

- Card reader slot for delegate identification
- 'Card accepted' LED indicator

Interconnection

- 2 m (78.74 in) flat ribbon cable with a 10-pole connector

Technical data

Mounting	Click-to-fit in a metal panel with a thickness of 2 mm (0.08 in) (4 screws optional)
Dimensions (H x W)	40 x 120 mm (1.57 x 4.72 in) (built-in depth approx 100 mm (3.93 in))
Weight	165 g (0.36 lb)
Colour	charcoal (PH 10736)



LBB 3539/00

Blanking Panel

The LBB 3539/00 Blanking Panel can be used to neatly close off a slot in a flush-mounted unit that is not in use. The panel can be removed if future expansion of the system requires that the slot be used.

Technical data

Mounting	click-to-fit in a metal panel with a thickness of 2 mm (0.08 in) (4 screws optional)
Dimensions (H x W)	40 x 120 mm (1.57 x 4.72 in) (built-in depth approx. 25 mm (0.98 in))
Weight	30 g (0.06 lb)
Colour	charcoal (PH 10736)

LBB 3527/00

Table-Top Housing for Loudspeaker LBB 3538/00 and Two Flush-Mounted Units

This housing enables the loudspeaker LBB 3538/00 to be used in table-top applications. The loudspeaker simply clicks into place in the housing, which is designed so the loudspeaker is facing the delegate, thus increasing intelligibility. It can also be used to mount two flush-mounted units e.g. the LBB 3537/00 microphone and LBB 3524/00 channel selector. For permanent applications, the housing can be fixed to the table-top by means of two screws.

Technical data

Dimensions (W x H x D)	120 x 73 x 80 mm (4.72 x 2.87 x 3.14 in)
Weight	170 g (0.37 lb)
Colour	charcoal (PH 10736)



Accessories

LBB 9510/20 Hand-Held Microphone

The hand-held LBB 9510/20 is an excellent microphone with almost frequency-independent cardioid directivity. It includes an on/off slide switch and a 3-pole XLR plug, and is supplied with a quick-release clamp for use with floor- or table-stands. A stand adaptor is provided for mounting on 3/8", 1/2" and 5/8" Whitworth screw fittings.

Note: An adaptor cable is needed to connect this microphone to the Dual Audio Interface Unit (LBB 3535/00) or the Multi-Purpose Connection Unit (LBB 3440/15). Refer to the DCN Installation and Operating manual for more information. A separate on/off switch is also required in most cases.



Technical data	
Mounting	using a clamp on floor or table stand
Dimensions (H x D)	210 x 53 mm (8.26 x 2.08 in)
Weight	300 g (0.66 lb)
Colour	dark grey (PH 10714)

LBB 9514/20 Gooseneck Microphone

Cardioid condenser microphone on a gooseneck (for use with Dual Audio Interface Unit LBB 3535/00 or Multi-Purpose Connection Unit LBB 3540/15). Fitted with a 3 m (118.11 in) cable.

Note: An adaptor cable is needed to connect this microphone to the Dual Audio Interface Unit (LBB 3535/00) or the Multi-Purpose Connection Unit (LBB 3440/15). Refer to the DCN Installation and Operating manual for more information. A separate on/off switch is also required in most cases.



Technical data	
Mounting	fixed on table-top
Dimensions (length)	400 mm (15.74 in) (microphone plus gooseneck)
Weight	450 g (0.99 lb)

LBB 9526/10 Lavalier Microphone

Omni-directional condenser microphone which can be carried either by a strap around the neck or attached to clothing using the integrated tie-clip. Fitted with a 10 m (393.70 in) cable with a 5-pole DIN-plug.

Note: An adaptor cable is needed to connect this microphone to the Dual Audio Interface Unit (LBB 3535/00) or the Multi-Purpose Connection Unit (LBB 3440/15). Refer to the DCN Installation and Operating manual for more information. A separate on/off switch is also required in most cases.

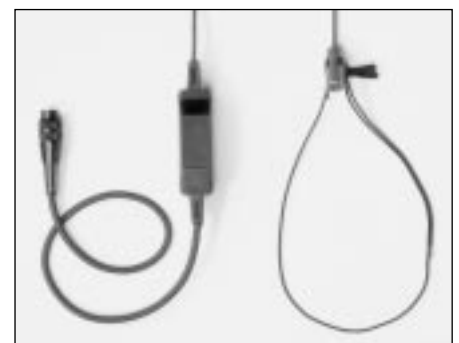

Technical data	
Mounting	neck strap or tie clip
Weight	260 g (0.57 lb)
Colour	dark grey (PH10714)

Digital Congress Network

Accessories

LBC 1215/01

Universal Microphone Clamp

Quick-release universal microphone clamp with a plastic swivel stand adaptor which is also suitable for conically shaped microphones. The clamp internal diameter range is 19 - 32 mm (0.74 - 1.25 in). The clamp is fitted to the floor stand LBC 1221/01 by a screw with a 3/8" Whitworth thread.

Technical data

Weight	60 g (0.13 lb)
Colour	black



LBC 1221/01

Floor Stand

Collapsible matt black floor stand, height adjustable from 85 to 160 cm (33.46 x 62.70 in). The widely spaced legs ensure good stability. The head of the stand has a standard 3/8" Whitworth thread.

Technical data

Dimensions (H x W)	folded 850 x 110 mm (33.46 x 4.33 in)
Weight	2.4 kg (5.28 lb)
Colour	black



LBC 1226/01

Adjustable Boom

Adjustable matt black boom with a quick-release boom lock. Maximum boom reach 67 cm (26.37 in). Fitted with a 3/8" Whitworth thread for connecting to floor stand LBC 1221/01.

Technical data

Dimensions (length)	840 mm (33.07 in)
Weight	700 g (1.54 lb)
Colour	black



LBB 4002/00

Profecta Acoustic Feedback Suppressor

The Profecta Audio Feedback Suppressor is a digital audio processor that is designed for use in difficult audio environments to increase the maximum sound pressure level (SPL). For more information, refer to the Profecta data brochure and Instructions For Use.



WMS 2700

VHF Multi-Channel Microphone System

This wireless microphone systems offers great freedom of movement for microphone users. A VHF signal provides the link between the microphone and receiver, and its compact design and high performance are ideal for conferences. The WMS 2700 comprises a system of equipment including receivers, transmitters (handheld and belt pack), quad antenna dividers and remote antennas.



Digital Congress Network

Overview

Introduction

Philips simultaneous interpretation and language distribution equipment satisfies the demands of today's multi-lingual conference, from informal bi-lingual group discussions up to full-scale international congresses where 10 or even more simultaneous interpretations are required. The modular design of the interpretation and distribution products means precisely the right-sized interpretation system can be constructed through a combination of the appropriate system elements, and expanding or reducing the system size for other conferences is achieved quickly and easily.

The range of products covers virtually any interpretation requirement. The interpreter desks can accommodate up to 15* different languages, and can be used stand-alone or as part of an integrated, operator-controlled system. When used stand-alone, the built-in microprocessor is manually programmed to allocate language channels, channel routing and interlocks. In operator-controlled sys-

tems, the desk is used in combination with DCN dedicated software (the Simultaneous Interpretation module LBB 3572) to form a completely integrated interpretation network. The Simultaneous Interpretation module facilitates pre-setting and monitoring interpretation status in such a system. It can accommodate direct and relay interpretations, and provides facilities for the creation of 15* interpreter booths, each with up to six interpreters. Delegate contribution units and channel selection units are available with facilities to select the required interpretation.

Language distribution

Both wired and wireless language distribution is possible in DCN systems. Wired language distribution involves using the DCN system cabling to distribute interpretations to conference participants. The interpretation(s) can be accessed by means of headphones connected to a channel selector unit or a contribution unit with a built-in channel selector.

Rapid channel selection is accomplished using up and down select keys. Channel selection is automatically limited to the number of language channels available, and up to 15* interpretations plus the floor language can be accessed.

An infra-red system is also available to provide wireless communication in conference venues. It offers excellent sound quality as well as freedom of movement for conference participants. Up to 16 channels can be provided, and high security is ensured as the infra-red signals cannot pass through the walls of the room. The number of delegates able to receive signals from the infra-red system is theoretically unlimited.

For further information on Philips infra-red language distribution equipment, please refer to page 3.11. There is also a separate brochure with full details on these products, a copy of which is available on request.

*On request, it is possible to have up to 30 language channels.

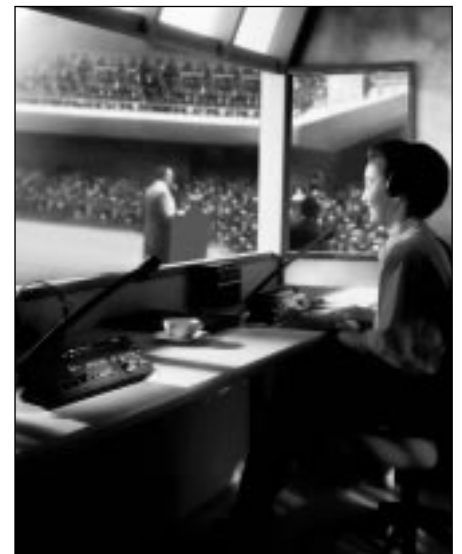

Digital Congress Network

Overview

Simultaneous interpretation equipment			
	Description	Comments	Page:
LBB 3520/10	Interpreter desk	Stand-alone or operator-controlled	3.3
LBB 9095/30	Interpreter headphones	For connecting to interpreter desk	3.4
LBB 3513/00	Analog Audio Input/Output Module	For remote interpretation via video conferencing or telephone link	3.5
LBB 3555/00	Intercom handset and cradle	Allows private conversations	3.6
LBB 3556/00	Mounting plate (for handset)	For mounting intercom cradle to interpreter desk	3.6
Wired language distribution equipment			
	Description	Comments	Page:
LBB 3518/00	Termination plug	For terminating DCN system cabling	3.10
LBB 3524/00	Electronic channel selector panel	For flush mounting in table-top or seat arm rests, or table-top use	3.7
LBB 3524/10	Electronic channel selector panel with backlighting	For flush mounting in table-top or seat arm rests, or table-top use	3.8
LBB 3526/10	Electronic channel selector panel with backlighting	For flush mounting in table-top or seat arm rests, or table-top use	3.9
LBB 3525/00	Table-top housing for channel selector	Accommodates LBB 3524/xx channel selector panel	3.10
Wireless language distribution equipment			
			Page:
	Overview of infra-red equipment		3.11
Delegate headphones and accessories			
	Description	Comments	Page:
LBB 3440/00	Lightweight headphones	Lightweight headphones with high-quality sound	3.12
LBB 3440/50	Replacement ear pads for LBB 3440/00	Single pair of replacement ear pads	3.12
LBB 3441/00	Under the chin headphones	Lightweight headphones with stethoscopic earpieces	3.12
LBB 3441/50	Replacement eartips for LBB 3441/00	Set of 1,000 eartips	3.12
LBB 3442/00	Single earphone	Lightweight earphone	3.12
LBB 3015/04	Dynamic headphones	High-quality sound reproduction	3.12
8222 231 16451	Replacement ear pads for LBB 3015/04	Single pair of replacement ear pads	3.12



Simultaneous Interpretation Equipment

LBB 3520/10

Interpreter Desk with LCD Screen

- Can accommodate up to 15 languages including the floor language
- Pre-select keys for language selection
- 'Quality indication' of incoming languages
- Backlit LCD screen for clearer information display
- Improved ergonomic design to simplify operation

The LBB 3520/10 is a single-user interpreter desk which conforms to internationally-agreed standards. This innovative and stylish microprocessor-controlled unit (A-B type) can accommodate up to 15 different language channels plus the original floor language. A maximum of six desks can be installed per booth. An LCD screen shows the selected language and other related information. The LCD screen has backlighting, which makes it easier to read, especially in conditions of poor lighting, and removes the need for external light sources.

Improved ergonomic design with coloured controls simplifies the use of this unit. In addition, new lines on front panel create a clearer link between buttons and the on-screen display, which also improves ease-of-use.

The LBB 3520/10 is suitable for stand-alone use or as part of a more comprehensive system. When used stand-alone, the built-in microprocessor is manually programmed to allocate language channels, channel routing and interlocks. In operator-controlled systems, the desk is used in combination with DCN dedicated software (and other interpreter desks) to form a completely integrated interpretation network.

Three pre-select keys on each unit eliminate the need to manually search through all available language channels. Interpreters can quickly pre-select the three incoming language channels of their choice, including the floor language. This leads to quick switching between languages and reduces the chance of operator errors. The desk alphanumeric display gives an at-a-glance indication of the selected language.

A further refinement is an indication of the 'quality level' of the incoming languages. Previously, interpreters had no way of knowing if they were receiving a direct or an indirect interpretation. This facility gives them the option of avoiding the use of an indirect interpretation if a direct interpretation is available.

Controls and indicators

- Condenser microphone with built-in pop- and windshield, mounted on a fold-away stem, complete with a light ring which illuminates when the microphone is on
- Built-in loudspeaker with volume control for distribution of the floor language when all the microphones in the booth are switched off
- Light grey headphone, volume, treble and bass controls
- Rotary selector switch for quick selection of the incoming language channel. Three channel selection keys with LED indication for quick access to interpreter-specified languages channels
- Light grey select key with LED indicators to specify the original floor language or the auto-relay language
- Dark red outgoing A-channel and B-channel select keys with channel select indicators
- Dark red outgoing B-channel selection keys (up/down)
- 'Channel engaged' indicators for both A and B outputs
- Liquid Crystal Display (LCD) with backlighting shows the following:
 - Incoming channel languages (channel number with 3-character language abbreviation i.e ENG, GER)
 - Incoming language quality indication
 - + = Interpretation based on original floor language (DIRECT)
 - - = Interpretation not based on original floor language (INDIRECT)



Digital Congress Network

Simultaneous Interpretation Equipment

- Outgoing languages (channel number with language, i.e ENGLISH, GERMAN)
- Messages
- Multi-lingual programming instructions when in installation mode
- Microphone on/off lever-type switch for secure microphone switching and clear indication of switch position
- 'Microphone status' indicator (red LED bar)
- Microphone 'Mute' key
- Selector switch for selection of either an external headset or built-in microphone
- Outgoing message key
- Call key (voice) to provide two-way communication between interpreter and chairman/operator

Note: If the Intercom Control software module (LBB 3572) is installed, interpreters can also communicate with other PC users, interpreters, officials, and even delegates. Communication can be either via the built-in microphone and headphones, or the Intercom Handset (LBB 3555/00) for extra privacy.

Interconnection

- Headphone or headset connector (5-pole 180° DIN-type socket wired according to IEC 574-3)
- 6.3 mm (0.25 in) and 3.5 mm (0.14 in) stereo jack headphone connectors
- 2 m (78.74 in) cable with a moulded 6-pole circular connector
- 6-pole circular connector for loop-through connections
- 6-pole modular jack connector for Intercom Handset LBB 3555/00

Technical data

Mounting	table-top (portable or fixed mounting)
Dimensions (H x W)	front 295 x 100 mm (11.61 x 3.93 in) (footprint on table approx. 295 x 110 mm (11.61 x 4.33 in))
Weight	approx. 1 kg (2.20 lb)
Colour	charcoal (PH 10736)
Power consumption factor (PCF)	2.5

LBB 9095/30

Interpreter Headphones

Lightweight, dynamic headphones with 1.5 m (59.05 in) cable terminated with a 6.3 mm (0.25 in) jack plug, for direct connection to Interpreters Desk LBB 3520/00.

Technical data

Impedance	2 x 720 Ω
Frequency response	250 Hz to 13 kHz (-10 dB)
Power handling capacity	200 mW
Sensitivity (1 kHz)	97 dB SPL/earpiece at 0 dBV/system 96 dB SPL/earpiece at 1 mW/earpiece
Weight	78 g (0.17 lb)
Colour	black/grey



Digital Congress Network

Simultaneous Interpretation Equipment

LBB 3513/00

Analog Audio Input/Output Module

- Enables remote interpretation via video conferencing or telephone link
- Interfaces DCN with external analogue audio/music and/or other DCN systems
- Can distribute DCN channels for external monitoring or recording
- Connection via standard DCN cabling

The LBB 3513/00 Analog Audio Input/Output module has two main functions. It allows external analogue audio signals to be distributed via the DCN language channels. It also allows all DCN distribution channels (except intercom channels) to be distributed to external systems. This enables, for example:

- Connecting an interpreter at a remote location via a standard telephone line, ISDN line or video conferencing link for remote simultaneous interpretations. Video conferencing allows the remote interpreter to see real-time images of the speaker on a TV/monitor.
- Distributing an external mono music source in a DCN interpreter channel. Delegates can listen to the music via a wired or wireless (infra-red) language distribution system.
- Coupling two separate DCN systems, which for example allows two systems to share one interpretation. Audio from a DCN system can also be sent to a public address or monitoring system.

The LBB 3513/00 is mounted from the rear of a 19" (3HU) Eurorack. Up to eight modules can be housed in one frame assembly. Each module connects to the DCN trunk cable, and has one analogue input and output. A maximum of 30 modules can be connected to a DCN system.

PCB Controls and indicators

- Limiter on/off switch with LED indication for optimising channel signal level input
- Two rotary switches for selecting input channels (1-15) and output channels (0-15)
- Module initialisation/de-initialisation switch*
- 2 LEDs indicating that the selected input and output channels are active
- 'Engaged' LED indicating that the selected input channel is in use
- Error indication LED
- LED indicating presence of remote control
- LED indicating that the module is not initialised
- Power ON LED

Interconnection

- 25-pole D-type male connector for connecting remote control panel
- Two 3-pole XLR connectors for input (female) and output (male) connections
- 6-pole circular female connector for loop-through connecting other modules/DCN units
- 0.3 m (12.6 in) cable terminated with 6-pole circular connector for connection to DCN trunk line

**Note: Before the Analog Audio Input/Output Module can be used in a DCN system, the module must first be initialised so that it is recognised by the DCN Central Control Unit. Initialisation is carried out by pressing the initialisation switch located on the front of the module PCB. The module can be de-initialised by pressing the switch again.*

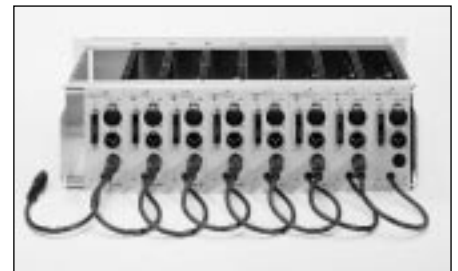

Technical data	
Audio input impedance (symmetrical)	>10 k Ω (without transformer)
Nominal audio input level	-3 dBV (limiter off), -24 dBV (limiter on)
Maximum audio input level	6 dBV
Audio output impedance (symmetrical)	<600 Ω at 1 kHz
Nominal audio output level (-9 dBFS)	1 dBV
Maximum audio output level (0 dBFS)	10 dBV (22 dBV for PA channel)
Maximum cable length for remote control	25 m (82 ft)
Mounting	19" rack
Connector panel dimensions (H x W)	128.4 x 50 mm (5.1 x 2.0 in)
Power consumption factor (PCF)	1

Digital Congress Network

Simultaneous Interpretation Equipment

LBB 3555/00

Intercom Handset and Cradle

- Ideal for intercom applications
- For use with all DCN Concentus units, MPCU and Interpreter desks
- Can be permanently mounted to wall, chair or table-top

Lightweight and compact, this robust and attractively-styled handset and cradle enables private 2-way conversation between conference participants.

The handset is hard-wired to the cradle by a coiled cable (0.5 m (19.68 in) coiled, 2 m (78.74 in) uncoiled). The cradle output cable is terminated with a 6-pole RJ connector for connection to Concentus and interpreter units, and the MPCU.

When used in permanent installations, the unit is easily mounted to a table-top or wall using the two screw holes in the cradle. In portable systems the handset can be simply attached to an interpreter unit with the aid of the LBB 3556/00 Mounting Plate.

Technical data

Mounting	
Permanent installations	table-top or wall mounted using the 2 screw holes on the cradle
Portable installations	using mounting plate LBB 3556/00, the cradle can be attached to an interpreter unit
Dimensions (H x W)	210 x 53 mm (8.26 x 2.08 in)
Weight	approx. 250 g (0.55 lb)
Colour	charcoal (PH 10736)



LBB 3556/00

Mounting Plate for LBB 3555/00

Metal mounting plate used to attach the intercom cradle (LBB 3555/00) to an interpreter unit.



Wired Language Distribution Equipment

LBB 3524/00

Electronic Channel Selector Panel

- Up/down select keys for easy channel selection
- Built-in 'silent' function
- LCD for currently-selected channel
- Automatically adapts to number of available channels

The LBB 3254/00 Electronic Channel Selector Panel, with up/down select keys, provides the delegate with an easy and reliable means of selecting language channels. Channel selection is automatically limited to the number of language channels available. Until this channel selector unit is used, i.e. before the language channel selection or volume control push buttons have been pressed, there is no output from the unit. This 'silent' function eliminates noise from headphones not yet in use. When any of these push buttons is pressed, the unit output is automatically activated, with 'floor' as a default setting for the channel selector buttons and the output volume set to a comfortable level.

The unit can be mounted in three ways:

- directly in table-tops or the arm rests of seats
- into the LBB 3527/00 Channel Selector Housing for Flush Mounting, which is then mounted in table-tops or the arm rests of seats
- into the LBB 3525/00 Table-Top Channel Selector Housing, for use in portable systems or on table-tops.

Controls and indicators

- Two push buttons (up/down) for language channel selection
- LCD screen for channel number indication
- Two push buttons (up/down) for volume control

Interconnection

- 3.5 mm (0.14 in) stereo jack headphone connector
- 2 m (78.74 in) cable terminated with a moulded 6-pole circular connector
- 6-pole circular connector for loop-through interconnection

Technical data	
Mounting	click-to-fit in a metal panel with a thickness of 2 mm (0.08 in) (4 screws optional)
Dimensions (H x W)	front panel 40 x 120 mm (1.57 x 4.72 in)
Weight	approx 200 g (0.44 lb)
Colour	charcoal (PH 10736)



Digital Congress Network

Wired Language Distribution Equipment

LBB 3524/10

Electronic Channel Selector Panel with Backlighting

- Integrated input and output cables
- Up/down select keys for easy channel selection
- Built-in 'silent' function
- Backlit, easily readable LCD for currently-selected channel
- Automatically adapts to number of available channels
- Possibility for connecting external headphone sockets

The LBB 3254/10 Electronic Channel Selector has two integrated cables, one for input and the other for output. The LCD screen is backlit so any text is easily legible in darkened congress venues. The backlighting is only active when a headphone is connected. Its up/down select keys provide the delegate with an easy and reliable means of selecting languages channels. Channel selection is automatically limited to the number of language channels available.



Until this channel selector unit is used, i.e. before the language channel selection or volume control push buttons have been pressed, there is no output from the unit. This silent function eliminates noise from headphones not yet in use. When any of these push buttons is pressed, the unit output is automatically activated, with floor as a default setting for the channel selector buttons and the output volume set to a comfortable level.

The unit can be mounted in three ways:

- directly in table-tops or the arm rests of seats
- into the LBB 3527/00 Channel Selector Housing for Flush Mounting, which is then mounted in table-tops or the arm rests of seats
- into the LBB 3525/00 Table-Top Channel Selector Housing, for use in portable systems or on table-tops.

Note: An unused output cable must be terminated by an LBB 3518/00 Termination Plug.

Controls and indicators

- Two push buttons (up/down) for language channel selection
- LCD screen for channel number indication
- Two push buttons (up/down) for volume control

Interconnection

- 3.5 mm (0.14 in) stereo jack headphone connector
- 1 m (39.37 in) input cable terminated with a moulded 6-pole male DIN DCN connector
- 1 m (39.37 in) output cable terminated with a moulded 6-pole female DIN DCN connector
- Soldering pads for connecting another type of headphone socket

Technical data

Mounting	click-to-fit in a metal panel with a thickness of 2 mm (0.08 in) (4 screws optional)
Dimensions (H x W)	front panel 40 x 120 mm (1.57 x 4.72 in) (built-in depth 55 mm (2.16 in))
Weight	approx 200 g (0.44 lb)
Colour	charcoal (PH 10736)

Wired Language Distribution Equipment

LBB 3526/10

Electronic Channel Selector Panel with Backlighting

- Integrated input and output cables
- Up/down select keys for easy channel selection
- Built-in 'silent' function
- Backlit, easily readable LCD for currently-selected channel
- Automatically adapts to number of available channels
- Possibility for connecting external headphone sockets

The LBB 3526/10 Electronic Channel Selector has two integrated cables, one for input and the other for output. The LCD screen is backlit so any text is easily legible in darkened congress venues. The backlighting is only active when a headphone is connected.

Its up/down select keys provide the delegate with an easy and reliable means of selecting language channels. Channel selection is automatically limited to the number of language channels available.

Until this channel selector unit is used, i.e. before the language channel selection or volume control push buttons have been pressed, there is no output from the unit. This silent function eliminates noise from headphones not yet in use. When any of these push buttons is pressed, the unit output is automatically activated, with floor as a default setting for the channel selector buttons and the output volume set to a comfortable level. The unit can be mounted directly in table-tops or the arm rests of seats.

Note: An unused output cable must be terminated by an LBB 3518/00 Termination Plug.

Controls and indicators

- Two push buttons (up/down) for language channel selection
- LCD screen for channel number indication
- Two push buttons (up/down) for volume control

Interconnection

- 6.35 mm (0.25 in) stereo jack headphone connector
- 1 m (39.37 in) input cable terminated with a moulded 6-pole male DIN DCN connector
- 1 m (39.37 in) output cable terminated with a moulded 6-pole female DIN DCN connector
- Soldering pads for connecting another type of headphone socket

Technical data	
Mounting	click-to-fit in a metal panel with a thickness of 2 mm (0.08 in) (4 screws optional)
Dimensions (H x W)	front panel 40 x 144 mm (1.57 x 5.66 in) (built-in depth 55 mm (2.16 in))
Weight	approx 250 g (0.55 lb)
Colour	charcoal (PH 10736)



Digital Congress Network

Wired Language Distribution Equipment

LBB 3525/00

Table-Top Housing for Channel Selector

This housing is ideal for use with portable/table-top systems. It is designed to neatly accommodate the Electronic Channel Selector Panel (LBB 3524/00 or LBB 3524/10).

Technical data	
Mounting	free-standing or fixed using integral screw mounting facilities
Cable exit	left or right side of unit
Dimensions (H x W x D)	70 x 135 x 95 mm (2.75 x 5.31 x 3.74 in)
Weight	210 g (0.46 lb)
Colour	charcoal (PH 10736)



LBB 3518/00

Termination plug for DCN cable

The LBB 3518/00 termination plug is specially designed for use with opened-ended DCN cabling. It is connected to the output cable on the last LBB 3524/10 Electronic Channel Selector Panel in a 'daisy-chain' configuration.

Digital Congress Network

Wireless Language Distribution Equipment

Infra-red language distribution equipment

The range of DCN infra-red language distribution equipment enables wireless transmission and reception of languages in all types of conference venues. A typical system consists of an infra-red transmitter, several radiators and individual infra-red receivers for delegates. Each infra-red language distribution system is assembled separately to ensure correct radiation intensity and subsequently a sufficient signal-to-noise ratio to provide clear reception in the conference area. Optimally positioned radiators lead to reduced installation and running costs.

Transmitters

Infra-red transmitters are available which generate a carrier wave for each language channel.

Radiators

Radiator units are used to distribute the infra-red signals throughout the conference venue. The LBB 3410/05 is a wide-beam model, and is suitable for smaller scale conferences. The LBB 3411/00 and LBB 3412/00 are high-power infra-red radiators, suitable for use in large conference venues. All radiators can be mounted unobtrusively on walls or ceilings.

Receivers

Philips infra-red receivers incorporate the latest electronics technology - including a specially-designed IC - to produce maximum performance, ergonomic design and long battery lifetime. They offer improved sound quality and higher maximum volume for enhanced speech intelligibility. An added feature is circuitry that automatically switches off the receiver if the user has left the infra-red reception zone for a preset period of time.

The LBB 3432 can accommodate two language channels and the LBB 3433 can accommodate seven. The LBB 3434 can accommodate up to 16 language channels and includes an upshift channel selection facility that eliminates interference from HF fluorescent lamps, an LCD display and a speech boost facility. All have a headphone socket for accessing to the appropriate language channel. All receivers are available in disposable battery-powered and rechargeable battery-powered versions.

Accessories

Quick charging units are available in suitcase-style (LBB 3406/00). They can accommodate up to 56 receiver units. Charging is microprocessor-controlled and takes a maximum of only 2.3 hours. Green and red LEDs at the charging positions indicate the charge status of each receiver. A Trickle Charging Suitcase

(LBB 3407/00) and a Trickle Charging Cabinet (LBB 3409/00) are also available. An Audipack 6402 Case is used to store receiver units not currently in use. It houses up to 100 receiver units and its compact design makes it easy to store. Full information on DCN infra-red equipment is provided in a separate brochure, available on request.



Receivers with headphones

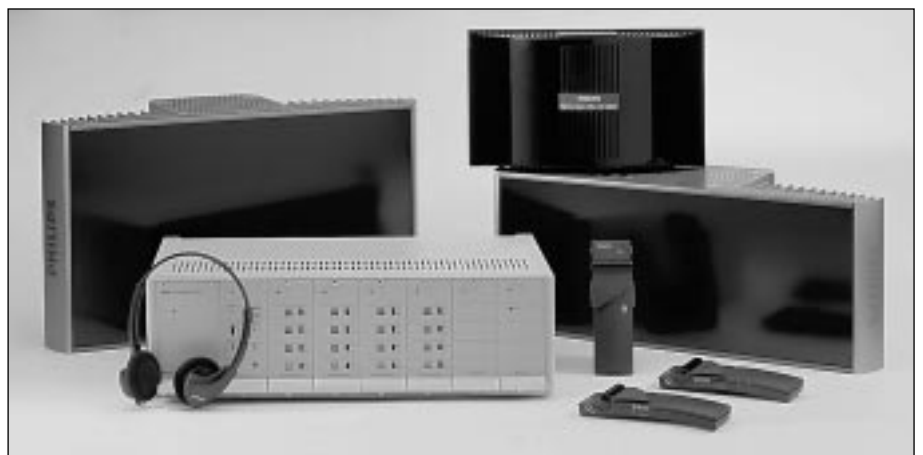

A range of transmitters and radiators



A choice of charging and storage units



Digital Congress Network

Delegate Headphones and Accessories

LBB 3440/00

Lightweight Headphones

Durable dynamic headphones offering high-quality sound reproduction.

Technical data

Weight	84 g (0.19 lb)
Colour	black



LBB 3440/50

Replacement Earpads for LBB 3044/00 Headphones

Set of 50 pairs of replacement earpads for headphones LBB 3440/00

LBB 3441/00

Under The Chin Headphones

Lightweight headphones for under the chin use. Fitted with 1.2 m (47.2 in) cable terminated with 3.5 mm (0.14 in) jack plug .

Technical data

Weight	33 g (0.07 lb)
Colour	black



LBB 3441/50

Replacement Eartips for LBB 3441/00 Headphones

Set of 1,000 replacement eartips for Under The Chin Headphones LBB 3441/00, allowing optimal hygiene in the use of these headphones.

LBB 3442/00

Single Earphone

Lightweight single earphone, fitted with a 1.2 m (47.2 in) cable terminated with a 3.5 mm (0.14 in) jack plug.

Technical data

Weight	25 g (0.06 lb)
Colour	dark grey



LBB 3015/04

High-Quality Dynamic Headphones

Durable dynamic headphones offering high-quality sound reproduction. Fitted with a 1.2 m (47.24 in) cable terminated with a 3.5 mm (0.14 in) jack plug.

Technical data

Weight	90 g (0.20 lb)
Colour	black/grey

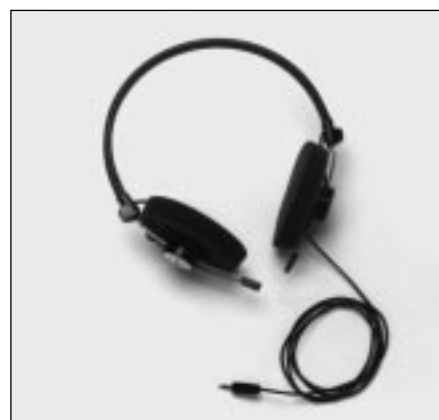

8222 231 1645 I

Replacement Earpads for LBB 3015/04 Headphones

Single pair of replacement earpads for headphones LBB 3015/04.

Digital Congress Network

Overview

Introduction

The DCN central conference control equipment is based around the Central Control Unit (CCU). This compact unit is at the heart of any DCN system, and can control up to 240 contribution units such as delegate- and chairman units, interpreter desks and audio and multipurpose interface units. The CCU can function with or without a central operator using a PC.

In smaller systems where an operator is not essential, the CCU is used as a stand-alone unit which provides basic microphone operational modes, basic parliamentary voting procedures and facilities for simultaneous interpretation.

In larger systems necessitating an operator, a PC serves as the interface between the operator and the DCN system. A wide range of Windows-based application software modules are available that are



run on the PC to provide comprehensive facilities for conference control and management. When fitted with a DCN network card, the PC can be connected

to any point in the system cabling. It is also possible to connect the PC directly to a CCU using an RS-232 port.

DCN central control equipment

Control units			
	Description	Comments	Page:
LBB 3500/05(D)*	Basic central control unit	Conference control without operator	4.2
LBB 3500/15(D)*	Extended central control unit	For operator-controlled conference	4.3
LBB 3500/35(D)*	Multi central control unit	Control for additional 240 units	4.5
Power supplies			
	Description	Comments	Page:
LBB 3506/00(D)*	Extension power supply	For power to additional contribution units	4.7
LBB 3508/00(D)*	Audio media interface/power supply	For connecting analogue equipment	4.8
Extension cards			
	Description	Comments	Page:
LBB 3510/00	PC network card	Allows PC to communicate with DCN	4.9
LBB 3511/00	PC card for multi-CCU systems	Allows communication between PC and Multi-CCUs	4.9
LBB 3519/20	Trunk communication board	For upgrading LBB 3500/xx CCUs	4.10
LBB 3512/00	Data distribution board	Communicates with hall displays, etc	4.10
Control unit accessories			
	Description	Comments	Page:
LBB 3555/00	Intercom handset and cradle	For operator/chairman	4.10
LBB 3015/04	Dynamic headphones	For high-quality sound	4.11
LBB 3559/05	Set of 100 Chip cards	Credit-card size Chip cards	4.11
LBB 3557/00	Chip card encoder	Used with encoder software LBB 3581	4.11
Personal computers			
	Description	Comments	Page:
	Overview of personal computers		4.12

**Note: Type numbers marked with a 'D', are intended for the North American market. They are CSA/UL approved, and have a modified mains supply and supply cord. They are identified by the letter 'D' being added to their typenumbers.*

Digital Congress Network

Control Units

LBB 3500/05, LBB 3500/05D*

Basic Central Control Unit

- Conference control without operator (stand-alone)
- Controls up to 240 contribution units
- Facilities for microphone management, voting and simultaneous interpretation
- Built-in automatic audio equalizer

**Note: Type numbers with a 'D' are intended for the North American market. They are CSA/UL approved, and have a modified mains supply and supply cord.*

The Basic Central Control Unit is the heart of a stand-alone discussion and conference control system. This compact and versatile unit includes features for controlling delegate microphones, distributing simultaneous interpretations and conducting voting sessions - all without the need of a central control operator.

The unit can be used free-standing on a table-top or mounted conveniently in a 19" rack housing.



- Built-in power supply unit to supply both the Central Control Unit and all externally connected DCN equipment. Up to 90 contribution units can be driven (this figure represents the number of units rated with a Power Consumption Factor [PCF] of 1.) For further information on the PCF, please refer to chapter 9, Technical Data)
- Control facilities for controlling up to 240 contribution units. This includes delegate and chairman units, interpreter desks, dual audio interface units and multi-purpose connection units
- Control facilities for an unlimited number of distribution units such as audio media interface units, data distribution boards and electronic channel selector units
- Digital audio control and processing facilities for thirty Hi-Q digital audio channels, which can be used for contribution, interpretation and distribution purposes. The unit also provides four separate communication channels
- Automatic audio equalizer for delegate and chairman loudspeakers
- Control and processing facilities for ten 64 kByte data channels
- Basic microphone management facilities for a wide variety of conference situations
- Three operational modes are available:
 - 'OPEN': microphone-key control with request-to-speak registration (AUTO)
 - 'OVERRIDE': microphone-key control with override of already active microphones (FIFO)
 - 'VOICE': voice-activated microphones
- Each mode of operation allows the selection of one, two or four delegates microphones to be activated simultaneously
- Basic voting control which provides a parliamentary voting procedure. Delegates can register 'PRESENT', 'FOR', 'AGAINST' and 'ABSTAIN'. Chairman can start, stop and suspend voting. The total results can be displayed on hall displays and on delegate/ chairman LCD screens
- Basic simultaneous interpretation functions with as many as 11 interpretation channels plus the floor language
- Automatic camera control (stand-alone)

Controls and indicators

- Mains on/off switch with green LED indicator
- 'Active Microphone' button with three yellow LED indicators to select the maximum number of delegates microphones which may be activated simultaneously (1, 2 or 4)
- 'Microphone Mode' button with three yellow LED indicators to select microphone operating mode (OPEN, OVERRIDE or VOICE)
- Equalizer button with two LED indicators to indicate ON (green LED) or BUSY (red LED) plus a switch to initiate automatic audio equalizer adjustment
- Rotary loudspeaker tone controls, for bass and treble adjustment
- Rotary loudspeaker volume control

Control Units

Interconnection

- Three outlet trunk-line cable connectors for connection of contribution, distribution, and interpretation units, plus extension power supplies. Each socket is protected against short-circuit. (3 x 6-pole circular connectors)
- Three indicators to indicate trunk-line overload (red LEDs)
- Two asymmetrical line input connectors (cinch-type) for floor input
- Symmetrical/ asymmetrical line output connectors (cinch-type) for distribution of floor language to public address systems
- Tape/cassette recorder input and output (cinch-type) for floor input and output
- Euro-mains socket with built-in fuse. Matching mains cable (1.7 m (66.92 in)) included
- Serial data connector for servicing purposes, and for automatic camera control (9-pole D-type connector)

Technical data	
Mounting	free-standing on a table-top or mounted in a 19" rack (requires 2U)
Dimensions (H x W x D)	100 x 440 x 308 mm (3.93 x 17.32 x 12.12 in)
width including 19" brackets*	483 mm (19.01 in)
depth including handles	348 mm (13.70 in)
Weight	9.3 kg (20.5 lb)
Colour	
- cabinet	light grey (PH 10709)
- handles	dark grey (PH 10711)
* 19" brackets are included	

LBB 3500/15, LBB 3500/15D*

Extended Central Control Unit

- Sophisticated operator-controlled conference management
- Allows access to DCN software modules
- Controls up to 240 contribution units
- Back-up system in the event of PC failure
- Direct PC control facility
- Two RS-232 ports for serial data communication

**Note: Type numbers with a 'D' are intended for the North American market. They are CSA/UL approved, and have a modified mains supply and supply cord.*

This highly sophisticated central control unit is used in combination with a personal computer to bring an extra dimension to conference control. Via the PC the user can access the extensive family of DCN software modules, each with a specific function in controlling and monitoring conferences. These modules greatly expand the possibilities in conference management, including advanced simultaneous interpretation and microphone management, message generation and display, three kinds of voting, intercom, creating a delegate database and attendance registration. In the event of PC failure the Extended Central Control Unit will revert to its default operation mode. This mode is identical to that of the Basic Central Control Unit, enabling the conference to proceed. The PC is connected to the unit using a PC network card (LBB 3510/00). Alternatively, the PC can directly control the CCU by connecting it to the CCU via an RS-232 port. In this case, no network card is required.

*Note: If the PC uses Windows 2000 or Windows NT 4.0, it **must** be directly connected to the CCU. For Windows 95/98 either direct control or control via the network card is possible. However, direct PC control and control by network card cannot simultaneously take place. If direct PC control is used, additional operator equipment is required to connect the Intercom Handset and Cradle (LBB 3555/00), and headphones for monitoring audio channels.*

- Built-in power supply unit to supply both the Central Control Unit and all externally connected DCN equipment. Up to 180 contribution units can be driven (with PCF of 1)



Digital Congress Network

Control Units

- Control facilities for controlling up to 240 contribution units. This includes delegate- and chairman units, interpreter desks, dual audio interface units and multi-purpose connection units
 - Control facilities for an unlimited number of distribution units such as audio media interface units, data distribution boards and electronic channel selector units
 - Digital audio control and processing facilities for thirty Hi-Q digital audio channels, which can be used for contribution, interpretation and distribution purposes. The unit also provides four separate communication channels
 - Automatic audio equalizer for delegate and chairman loudspeakers
 - Control and processing facilities for ten 64 kByte data channels
 - Basic microphone management facilities for a wide variety of conference situations
 - Three operational modes are available:
 - 'OPEN': microphone-key control with request-to-speak registration (AUTO)
 - 'OVERRIDE': microphone-key control with override of already active microphones (FIFO)
 - 'VOICE': voice-activated microphones
- Each mode of operation allows the selection of one, two or four delegate's microphones to be activated simultaneously
- Extended microphone management facilities depending on installed software (Microphone Management and/or Synoptic Microphone Control)
 - Basic voting control which provides a parliamentary voting procedure. Delegates can register 'PRESENT', 'FOR', 'AGAINST' and 'ABSTAIN'. Chairman can start, stop and suspend voting. The total results can also be displayed on hall displays and on contribution unit LCD screens
 - Extended voting facilities depending on installed software: Parliamentary Voting for parliamentary voting or Multi Voting for six voting types: Parliamentary Voting, Audience Response, Rating, Multiple Choice, For/Against and Opinion Poll
 - Basic simultaneous interpretation functions with as many as 11 interpretation channels plus the floor language
 - Extended simultaneous interpretation facilities if the Simultaneous Interpretation software module is installed. These include:
 - Channel/desk assignment
 - Specifying the microphone interlock mode
 - Printing interpreter configuration information
 - On-line monitoring of interpreter activity
 - Monitoring channel- and desk routing
 - 15 interpretation channels plus floor

Additional extended facilities depending on software include:

- Intercommunication
- Delegates Database compilation
- Attendance registration
- Message generation and distribution
- Hall text display of conference-related data
- Hall video display

Controls and indicators

- Mains on/off switch with green LED indicator
- 'Active Microphone' button with 3 yellow LED indicators to select the maximum number of delegate microphones which may be active simultaneously (1, 2, or 4) in stand-alone systems
- 'Microphone Mode' button with 3 yellow LED indicators to select microphone operating mode (OPEN, OVERRIDE OR VOICE) in stand-alone systems
- Equalizer button with 2 LED indicators to indicate ON (green LED) or BUSY (red LED) plus a switch for automatic audio equalizer adjustment
- Rotary loudspeaker tone controls for bass and treble adjustment
- Rotary loudspeaker volume control

Interconnection

- Three outlet trunk-line cable connectors for connection of contribution, distribution and interpretation units, plus extension power supplies. Each socket is protected against short-circuit. (3 x 6-pole circular connectors)
- Three indicators to indicate trunk-line overload (red LEDs)
- Two asymmetrical line input connectors (cinch-type) for floor input

Digital Congress Network

Control Units

- Symmetrical/ asymmetrical line output connectors (cinch-type) for distribution of floor language to public address systems
- Tape/cassette recorder input and output (cinch-type) for floor input and output
- Euro-mains socket with built-in fuse, matching mains cable (1.7 m) (66,92 in) included
- Two RS-232 serial data connectors for PC, camera control system, remote control systems/devices, diagnostic equipment. By default, port 1 is for PC (max. 115,200 baud), port 2 is for camera control.

Technical data	
Mounting	free-standing on a table-top or mounted in a 19" rack (requires 2U)
Dimensions (H x W x D) width including 19" brackets* depth with handles:	100 x 440 x 308 mm (3.93 x 17.32 x 12.12 in) 483 mm (19.01 in) 348 mm (13.70 in)
Weight	10.9 kg (24.0 lb)
Colour - cabinet - handles	light grey (PH 10709) dark grey (PH 10711)
* 19" brackets are included	

LBB 3500/35, LBB 3500/35D*

Multi Central Control Unit

- Extends congress systems by up to 240 contribution units
- Can be used in single or multi-CCU mode
- Direct PC control facility
- Two RS-232 ports for direct PC control

**Note: Type numbers with a 'D' are intended for the North American market. They are CSA/UL approved, and have a modified mains supply and supply cord.*

The LBB 3500/35 is functionally identical to the LBB 3500/15 Central Control Unit (CCU), and is used to extend the capacity of the DCN system. This unit is designed for situations where more than 240 contribution units are required. Multi-CCU systems are controlled from a separate, dedicated PC running the Multi-CCU software (LBB 3586) and equipped with the LBB 3511/00 PC Card. All Multi-CCU units and the LBB 3511/00 PC Card are interconnected via a closed loop coaxial cable.

Each subsequent Multi-CCU that is added increases system capacity by a further 240, if future expansion is anticipated. If the current number of contribution units is less than 240, the LBB 3500/35 can be used in single-CCU mode and functions as a LBB 3500/15 CCU. The operating mode is altered by means of a front panel switch. This flexibility means it can cater for virtually every conference requirement.

The DCN control PC is connected to the master CCU PC (running OS/2) via their respective serial ports.

Note: Additional operator equipment is required to connect the Intercom Handset and Cradle (LBB 3555/00), and headphones for monitoring audio channels.

When used in single-CCU mode, the functionality of the LBB 3500/35 is identical to the LBB 3500/15 Central Control Unit (CCU). When used in multi-CCU mode, specific functions include:



Digital Congress Network

Control Units

- Up to 16 Multi-CCUs can be interconnected, allowing up to 3840 contribution units to be connected to the DCN system (when used with the Delegate Database software module (LBB 3580), the maximum number of contribution units is 1500)
- Can operate single or in Multi-CCU mode
- Built-in power supply unit to supply both the Multi-CCU and externally-connected DCN equipment. Up to 180 units of PCF 1 can be driven per CCU
- Control facilities for up to 240 contribution units per CCU
- Automatic audio equaliser for adjusting the frequency response of contribution unit loudspeaker channels per CCU
- Two basic microphone operational modes are available:
 - 'OPEN': microphone-key control with request-to-speak registration
 - 'OVERRIDE': microphone-key control with override of already-active microphones (FIFO)
- Each microphone operation mode allows one, two or four microphones to be simultaneously active
- Basic parliamentary voting control facilities. Delegates can register 'PRESENT', 'FOR', 'AGAINST' and 'ABSTAIN'. The total results can also be displayed on hall displays and on contribution unit LCD screens
- Basic simultaneous interpretation functions with as many as 11 interpretation channels plus the floor language
- Extended facilities are available if the Multi-CCU is connected to a PC running DCN software. For more details on the software available, please refer to chapter 5 (Application Software)
- Camera control or remote control via serial communication with master CCU PC

Controls and indicators

- Mains on/off switch with green LED indicator
- 'Active Microphone' button with three yellow LED indicators to select the maximum number of delegate microphones which may be active simultaneously (one, two, or four) in stand-alone systems
- 'Microphone Mode' button with three yellow LED indicators to select microphone operating mode (OPEN, OVERRIDE OR VOICE) in single-CCU systems
- Equalizer button with 2 LED indicators to indicate ON (green LED) or BUSY (red LED) plus a switch for automatic audio equalizer adjustment
- Rotary loudspeaker tone controls for bass and treble adjustment
- Rotary loudspeaker volume control
- Switch to select single or Multi-CCU operating mode, with error indication (only when operating in the single [stand-alone] mode)

Interconnection

- Three outlet trunk-line cable connectors for connection of contribution, distribution, and interpretation units, plus extension power supplies. Each socket is protected against short-circuit. (3 x 6-pole circular connectors)
- Two rear-panel BNC connectors for input and output closed loop connections to other Multi-CCUs and the Multi-CCU PC
- Three indicators to indicate trunk-line overload (red LEDs)
- Two asymmetrical line input connectors (cinch-type) for floor input
- Symmetrical/asymmetrical line output connectors (cinch-type) for distribution of floor language to public address systems
- Tape/cassette recorder input and output (cinch type) for floor input and output
- Euro-mains socket with built-in fuse. Matching mains cable (1.7 m) (66.92 in) included
- Two RS-232 serial data connectors for PC, camera control system, remote control systems/devices, diagnostic equipment. By default, port 1 is for PC (max. 115,200 baud), port 2 is for camera control (for use in single CCU mode).

Power Supplies

Technical data	
Mounting	free-standing on a table-top or mounted in a 19" rack (requires 2U)
Dimensions (H x W x D)	100 x 440 x 308 mm (3.93 x 17.32 x 12.12 in)
width including 19" brackets*	483 mm (19.01 in)
depth including handles	348 mm (13.70 in)
Weight	11.2 kg (24.7 lb)
Colour	
- cabinet	light grey (PH 10709)
- handles	dark grey (PH 10711)
* 19" brackets are included	

LBB 3506/00, LBB 3506/00D*

Extension Power Supply Unit

- Powers up to 180 additional contribution units (with PCF of 1)
- Remote mains on/off
- Easy connection to DCN

**Note: Type numbers with a 'D' are intended for the North American market. They are CSA/UL approved, and have a modified mains supply and supply cord.*

The Extension Power Supply unit is used in combination with a CCU to supply power to a maximum of 180 additional units. (This figure represents the number of units rated with a Power Consumption Factor (PCF) of 1. For further information on the PCF, please refer to chapter 9, Technical Data). The unit can be installed at any convenient point in the system cabling due to its built-in trunk-line splitter. It is connected using loop-through cabling. The unit switches on automatically when the CCU is switched on. All outputs are protected against short circuit. It can be used free-standing on a table-top or mounted in a 19" rack.

Controls and indicators

- 'Power on' LED indicator

Interconnection

- Euro-mains socket with built-in fuse holder, mains cable 1.7 m (66.92 in) included
- 2 m (78.74 in) cable terminated with a moulded 6-pole circular connector
- Three outlet trunk-line cable connectors for connection of contribution, distribution, and interpretation units, plus extension power supplies. Each socket is protected against short-circuit (3 x 6-pole circular connectors)
- Three indicators to indicate trunk-line overload (red LEDs)

Technical data	
Mounting	free-standing on a table-top or mounted in a 19" rack unit * (requires 2U, ½ width)
Dimensions (H x W x D)	100 x 220 x 308 mm (3.93 x 8.66 x 12.12 in)
depth including handles	348 mm (13.70 in)
Weight	8.3 kg (18.26 lb)
Colour	
- cabinet	light grey (PH 10709)
- handles	dark grey (PH 10711)
* 19" brackets are included	



Digital Congress Network

Power Supplies

LBB 3508/00, LBB 3508/00D*

Audio Media Interface and Power Supply Unit

- Enables analogue equipment to be connected to the DCN outputs
- Powers up to 90 contribution units (with a PCF of 1)
- Can be connected to the system at any point
- Remote power on/off

**Note: Type numbers with a 'D' are intended for the North American market. They are CSA/UL approved, and have a modified mains supply and supply cord.*



The Audio Media Interface and Power Supply Unit enables external analogue equipment such as broadcast, recording and wired or wireless sound distribution equipment to be connected to the DCN system. This unit is equipped with four digital to analogue converters and channel selection switches for selecting the floor language or interpretation channels.

The LBB 3508/00 has a built-in power supply which can drive up to 90 additional units. A built-in trunk-line splitter enables it to be connected to the trunk-line at any point, using loop-through cabling.

The unit switches on automatically when the main CCU is switched on. It can be used free-standing on a table-top or mounted in a 19" rack.

Controls and indicators

- 'Power on' LED indicator
- 4 x 15-position rotary channel selector controls
- 5-position output selector to specify audio output for monitoring (Output 1 - 4 and off)

Interconnection

- 2 m (78.74 in) cable terminated with a moulded 6-pole circular connector
- Three outlet trunk-line cable connectors for connection of contribution, distribution, and interpretation units, plus extension power supplies. Each socket is short-circuit protected. (3 x 6-pole circular connectors)
- Three indicators for trunk-line overload (red LEDs)
- 4 x 3-pin XLR audio output sockets (0 dB balanced)
- Four cinch audio output connectors (-12 dB)
- Euro-mains socket with built-in fuse, mains cable 1.7 m (66.92 in) included
- 6.3 mm (0.25 in) stereo jack headphone connector for audio monitoring

Technical data

Mounting	free-standing on a table-top or mounted in a 19" rack unit* (requires 2U)
Dimensions (H x W x D) depth including handles	100 x 440 x 308 mm (3.93 x 17.32 x 12.12 in) 348 mm (13.70 in)
Weight	9.1 kg (20.02 lb)
Colour	
- cabinet	light grey (PH 10709)
- handles	dark grey (PH 10711)

* 19" brackets are included

Extension Cards and Accessories

LBB 3510/00

Network Card for Personal Computer

- Allows PC to communicate with DCN for application software control functions
- Headphone socket
- Intercom handset socket
- Optically-isolated inputs and outputs
- For use with Windows 95/98

This network card enables a PC to communicate with the DCN system. It is installed in the ISA-bus expansion slot at the back of the PC. The DCN software modules can then be run on the PC. The card also includes a headphone socket for audio monitoring and an intercom handset socket for audio communication. When connected to the DCN system its input and outputs are optically isolated.

Note: This network card can only be used for PCs using Windows 95 and Windows 98. It is also possible to directly connect the PC to the CCU of the DCN system via an RS-232 port. For PCs using Windows NT 4.0 and Windows 2000, this is the only way the PC can be connected to the DCN system. Direct connection and connection using the network card are not simultaneously possible.

Note: If the control PC is directly connected to the CCU, additional operator equipment is required to connect the Intercom Handset and Cradle (LBB 3555/00), and headphone connection.

Interconnection

- 8-bit ISA-bus connector
- 3.5 mm (0.14 in) stereo jack socket for operator headphones
- Socket for Intercom Handset LBB 3555/00
- Jumper to select one of five addresses
- 2 m (78.74 in) trunk-line input cable, terminated with a 6-pole moulded circular connector (male) and a 9-pole D-sub plug (female) matching the 9-pole PCB socket on the card

Technical data

Dimensions (H x W)	100 x 147 mm (3.93 x 5.78 in) (0.5 AT slot length)
--------------------	--

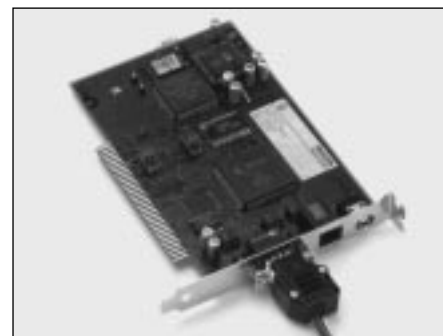

LBB 3511/00

PC Card for Multi-CCU Systems

This card provides the interface for communication between the PC and interconnected Multi-CCUs, type LBB 3500/35. It is installed in an 16-bit ISA-bus expansion slot of a personal computer.

The PC Card should be installed in a secondary dedicated PC, running OS/2, and not in the main PC running the DCN control software in Windows. Once the card and the Multi-CCU software package LBB 3586 is installed, the PC acts as the master network provider for all Multi-CCUs connected to the multi-CCU network. A maximum of 16 Multi-CCUs can be connected to the card, in a closed loop configuration, using the two BNC connectors on the card. Standard 75 Ω (RG 59) coaxial cable is used to make the connection.

Controls and indicators

- Output port I
- DIP switches to define the card's digital input
- DIP switches to define the card's I/O-address
- Red, Green and Yellow LEDs

Interconnection

- Input connection for external power-fail signal (active low)
- BNC connector for 'Multi-trunk Out'
- BNC connector for 'Multi-trunk In'
- 16 bit ISA-bus connector

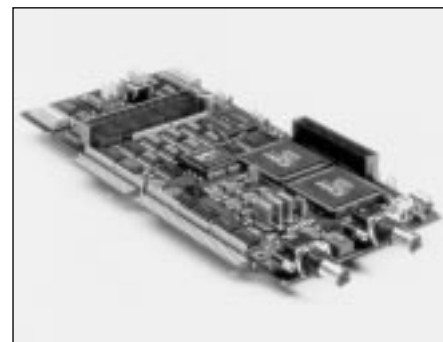

Digital Congress Network

Extension Cards and Accessories

Technical data

Dimensions (H x W) 100 x 220 mm (3.93 x 8.66 in) (for AT slot)

LBB 3512/00

Data Distribution Board

- Drives hall displays and camera systems
- Allows transparent data transport for remote control of external equipment

This printed circuit board is used with digital equipment such as hall displays, recorder systems and camera controllers to provide the data communication link to the DCN.

Note: For more information, refer to section 6 (DCN Information Displays).

LBB 3519/20

Trunk Communication Board

The LBB 3519/20 Trunk Communication Board is required for LBB 3500/xx CCUs for upgrading purposes.

The Trunk Communication Board can easily be fitted into the CCU. Full installation instructions are supplied with the board.

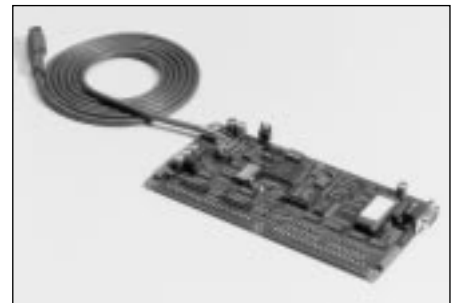

LBB 3555/00

Intercom Handset and Cradle

- Ideal for intercom applications
- For use with PC (only when PC network card LBB 3510/00 is used)
- Can be permanently mounted to wall, chair or table-top

Lightweight and compact, this robust and attractively-styled handset and cradle enables private 2-way conversation between conference participants, interpreters and the operator.

The handset is hard-wired to the cradle by a coiled cable (0.5 m (19.6 in) coiled, 2 m (78.74 in) uncoiled). The cradle output cable is terminated with a 6-pole RJ connector for connection to the LBB 3510 Network Card for Personal Computer.

When used in permanent installations, the unit is easily mounted to a table-top or wall using the two screw holes in the cradle.



Technical data

Mounting	table-top or wall-mounted using the 2 screw holes on the cradle
Dimensions (H x W)	53 x 210 mm (2.08 x 8.26 in)
Weight	approx. 250 g (0.55 lb)
Colour	charcoal (PH 10736)

Digital Congress Network

Accessories

LBB 3015/04

High-Quality Dynamic Headphones

Durable dynamic headphones offering high-quality sound reproduction. Fitted with a 1.2 m (47.24 in) cable terminated with a 3.5 mm (0.14 in) jack plug.

Technical data	
Impedance	360 Ω
Frequency response	250 Hz to 13 kHz (-10 dB)
Power handling capacity	200 mW
Sensitivity (1 kHz)	97 dB SPL/earpiece at 0 dBV/system 96 dB SPL/earpiece at 1 mW/system
Weight	90 g (0.20 lb)
Colour	black/grey



8222 231 16451

Replacement Earpads for LBB 3015/04 Headphones

Single pair of replacement earpads for High-Quality Dynamic Headphones LBB 3015/04.

LBB 3559/05

Set of 100 Chip Cards

These standard credit-card format chip cards are used by delegates to identify themselves to the DCN system. This can be a prerequisite for access to contribution units and activities such as attendance registration and voting.

The cards have an attractive design and ample space for a name or other delegate personal information. The card contains clear instructions showing how to insert the card into a reader.



LBB 3557/00

Chip Card Encoder

Used in combination with the Chip Card Encoder software module (LBB 3581), the LBB 3557/00 encodes delegate chip cards (LBB 3559/00).

Technical data	
Dimensions (H x W x D)	25 x 101 x 132 mm (1.0 x 4.0 x 5.2 in)

* This is equivalent to the Philips PE 132 Chip-Card Encoder or the De La Rue DE 132 Chip-Card Encoder



Digital Congress Network

Personal Computers

Introduction

To meet the ever-changing requirements of the modern conference plus the demands brought on by technological developments, the DCN system has now integrated conference control and management with the power, speed and general familiarity of a personal computer. Using a standard PC together with the DCN network card LBB 3510/00 (or direct PC control) and the wide range of application software modules, the PC is able to carry out all necessary functions to satisfy the demands of virtually any conference situation. The Philips DCN system includes a comprehensive range of software modules for conference management. All programmes run in the graphics-rich Windows® environment and it is possible to make a hard copy of conference information by connecting a laser printer, and program delegate chip cards via an chip-card encoder. As a result, conferences of virtually any size and magnitude can be easily controlled.

The minimum PC configuration is the same as recommended by Microsoft for Windows 95, 98, 2000 and NT.

The recommended hardware requirement for Windows 95 and 98 is:

- Pentium II processor or higher
- 48 MB Random Access Memory (RAM) or more (32 MB minimum)
- Video card supporting at least VGA and SVGA resolutions
- Hard disk with a data access time of <14 ms and >100 MB free disk space
- Ethernet network card for multi-PC systems
- Free ISA slot for Network Card LBB 3510/00 or free RS232 port for direct CCU connection
- Serial ports (RS232) for connection of:
 - Card encoder/reader
 - CCU (if no Network Card LBB 3510/00 is used), recommended baudrate 115,200
 - Label printer
 - Error logging
 - Microphone activity printing

Note: A PC with at least four serial ports is recommended if a direct CCU connection and card encoder is used.

- Parallel printer port for printer connection:
- Connections for:
 - Keyboard
 - Mouse

The recommended hardware requirement for Windows 2000, NT 4.0 or higher is as for Windows 95 and 98 with the following exceptions:

- 96 MB Random Access Memory (RAM) or more (64 MB minimum)
- Free serial port for CCU connection, baudrate 115,200

The following equipment is optional:

- Printers
- ID-card encoder

Minimum software and hardware requirements for Multi-CCU PC

- Pentium processor
- 16 MB Random Access Memory (RAM)
- 256 KByte cache memory
- Floppy disk drive, 3½" 1.44 MB
- Video card: SVGA resolution 640 x 480 pixels x 256 colours
- 1 MB Video memory
- Spare slot for PC card for a MCCU system LBB 3511/00
- 1 COM port and 1 parallel port
- 420 MB Hard disk with a data access time < 14 ms
- OS/2® version 2.11 or higher
- Serial 2-button mouse
- Local bus mouse port
- Keyboard
- Monitor

Digital Congress Network

Overview

Introduction

Philips offers a comprehensive range of software modules for use with DCN systems. These modules are run on a system-connected PC in Microsoft Windows, and integrate conference preparation, management and control into this versatile graphical computer environment. Any combination of modules can be loaded according to specific system requirements. This software is generally used in larger scale systems where operator control is required.

The PC running the software is connected to the DCN system and therefore has direct links with contribution, interpretation and control equipment via the system trunk bus. Thus all aspects of conference management can be brought to a single point of control, which leads to increased ease of use, efficiency and data distribution.

Running DCN software under Windows

Windows permits more than one application to be run at a time and information transfer between applications is possible. As many DCN software modules interact with each other and rely on shared data, the multi-tasking aspect of Windows is an important feature. The Windows graphical user interface is highly visual, and the

DCN software also makes full use of this capability to control conferences. Standard Windows conventions and operating procedures are used in all DCN software modules. Icons are used for representing various elements. This includes application icons for minimised active applications, document icons, and icons representing delegate units, interpreter units and floor microphones. These last types of icons may also function as a button or an indicator according to the requirements of the particular application.

The choice of which DCN software modules to install is based on specific system requirements. While Startup and System Installation are always required, modules such as Video Display are only required if there are video display facilities in the conference venue. Additional modules can easily be added to the system if required, for instance when new hardware is added or the conference changes from unilingual to multilingual.

An on-screen help facility provides functional and background information on the current module. The use of hypertext in the help facility simplifies accessing the required information.

DCN software for new and existing users

The DCN application software is often available in more than one form. This has been done to offer the best possible solution to both new and existing users. This works as follows:

Application software which has a type number ending with /00 is intended for users who currently do not have any versions of that software. This can apply to users who currently have no DCN application software, or those who use certain application software modules but wish to order different ones.

Software which has a type number ending with /09 is known as an upgrade version. These software versions can only be installed if a /00 version is currently installed. Installation of the LBB 3590/09 software automatically upgrades all other already-installed software applications.

DCN software (x = available)

Type number	/00	/09	Description	Comments	Page:
LBB 3590	x	x	DCN Startup	The basic platform for DCN software	5.2
LBB 3570	x		Microphone Management	Microphone control by participant name	5.2
LBB 3571	x		Synoptic Microphone Control	Microphone control by geographic/seating plan	5.3
LBB 3572	x		Simultaneous interpretation	For multi-lingual conferences	5.5
LBB 3573	x		Intercom	Controls two-way private communication	5.6
LBB 3575	x		Parliamentary Voting	Controls yes/no voting sessions	5.7
LBB 3576	x		Multi Voting	For monitoring audience opinion	5.8
LBB 3578	x		Attendance Registration and Access Control	For use with PIN code and ID-card	5.9
LBB 3580	x		Delegate Database	Conference database management	5.9
LBB 3581	x		ID-card Encoder	Driver for card-encoder	5.10
LBB 3582	x		Message Distribution	For personal or hall displays	5.11
LBB 3583	x		Text/Status Display	For alphanumeric/geographic displays	5.11
LBB 3584	x		Video Display	For driving monitors, Vidiwalls and projectors	5.12
LBB 3585	x		System Installation	For setting up configuration	5.13
LBB 3586	x	x	Multi-CCU Control Software	For controlling multiple CCUs in a DCN system	5.14
LBB 3587	x		Open Interface	For DCN remote control	5.15
LBB 3588	x		Camera Control with Control PC	For configuring and controlling conference cameras	5.14
LBB 3562	x	x	Stand-alone Camera Control	For configuring and controlling conference cameras	5.14

Digital Congress Network

Startup and Application Modules

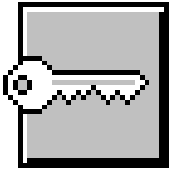

LBB 3590

DCN Startup Screen

- On-screen help facility

The Startup screen is active whenever DCN software modules are used for controlling and monitoring conference procedures. This module is different from all other DCN software modules because it is primarily used as a platform from which the other modules are selected.

However, this is only aspect of Startup. The following can also be carried out:

- Setting operator headphone and master volume levels, and selecting the channel for the operator to monitor
- Opening, closing and deleting Installation Files and Names Files
- Configuring the Startup program to automatically load selected DCN modules
- Accessing, acknowledging and printing error messages

When Startup is loaded, it presents the user with a desktop window that is the DCN opening screen. The other DCN modules are represented by icons in this opening screen, and can be activated simply by clicking on them. Startup also has a facility which allows other DCN modules to be loaded automatically. This saves having to manually select modules that are used virtually every time the DCN system is in operation. The user can specify any combination of modules for automatic Startup.

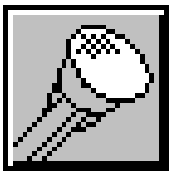

LBB 3570

Microphone Management

- Single-point control of all microphone units
- Various microphone control options
- Extensive range of options for microphone-related parameters
- Output to printer and/or external equipment such as cameras
- On-screen help facility

The efficient management of delegate microphone status is a vital element in successful conference control. The Microphone Management software module provides the user with a powerful and easy-to-use tool that brings all aspects of microphone management to a single point of control. Microphones are controlled using the name (or desk number) of the delegate. The user can select microphones for the speakers list (active microphones) or prepare a request list. The order of delegates within the request list and speakers list can be altered at any time before or during a conference. A search facility is available that allows the operator to locate specific delegates.

It is also possible to give notebook status to delegates, which means they do not have to join the request list and can enjoy certain other privileges not granted to other delegates. The microphone type must be specified for the notebook. The possibilities are:

- 'Chair' for chairman microphones
- 'Key' where delegates activate their microphones by pressing their microphone buttons
- 'Operator' where the microphones of more active delegates are activated by the operator

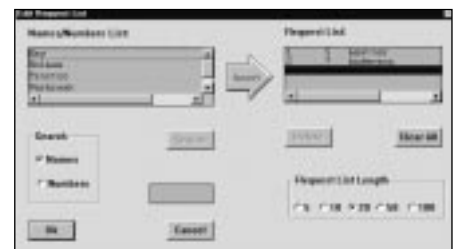

Application Modules

The DCN system automatically recognises an assigned chairman unit and will automatically add it to the notebook.

Microphone Management offers a number of microphone control options. This has a bearing on both how the Microphone Management module operates and how the conference itself proceeds. These options are:

- Control by operator with request-to-speak list (manual)
- Control by operator with request-to-speak list and response list
- Control by delegate with request-to-speak list (open)
- Control by delegate with override of other delegate microphones (first-in-first-out)
- Control by delegate with voice activation

Each mode allows a different level of both operator and delegate control, so almost all situations can be covered. For example, smaller, informal discussions require very little operator control, so a mode such as control by delegate would be ideal. For a full-scale international conference with hundreds of participants, control by operator with request-to-speak list would be appropriate. The operator can specify whether one, two, three or four normal delegate microphones can be active simultaneously. It is also possible to specify whether delegates are allowed to cancel requests to speak or switch their microphones off. The amount of time delegates are allowed to speak can also be specified.

A number of options are available as to how the conference information is presented. The contents of the main window can be altered, and how each delegate is represented in any of the lists is also user-definable. There is a facility to automatically test and scan all installed microphones individually, with or without a sound generator. The microphone under test is indicated on-screen and the results of the test are made known to the system operator.

This program can also be used in combination with the Text/Status Display module, LBB 3583, to show delegate names or seat numbers on a hall display as soon as they are present on the speakers list or request-to-speak list. Delegates microphone activity can be recorded on file or sent to a printer. Microphone activity data is also made available for controlling external equipment such as an automatic camera system.

During a conference the main window is used for monitoring and controlling delegate microphone status. Depending on the operating mode, delegate microphones can be switched on or off by simply clicking on the screen microphone icon, or double-clicking on a delegates name. A single click on a delegate name allows the operator to either insert, delete or replace the delegate from the request-to speak list.

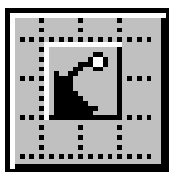

LBB 3571

Synoptic Microphone Control

- Easily-created synoptic layout used for microphone control
- Single-point control of all microphone units
- Various microphone control options
- Output to printer and/or external equipment such as cameras
- On-screen help facility

This software module takes microphone control away from the traditional method of control panels and keys and replaces it with an extremely user-friendly, on-screen means of managing microphone status. A graphical representation of the contribution units in a conference venue is created and then used to control the microphone status



Digital Congress Network

Application Modules

of delegates. Through the use of different icons and colours, the user has an at-a-glance overview of the status of all conference participants. The result is a highly visual 'push-button' conference control facility.

There are two modes of operation within Synoptic Microphone Control; layout mode and control mode.

Layout mode

In layout mode the user creates a graphical representation of the contribution units present in the conference venue. This representation - the synoptic layout - is in essence a plan view of the conference venue. Layout mode contains dedicated tools for this purpose. Icons representing the contribution equipment are used to build up the layout. Each item of contribution equipment (delegate unit, chairman unit, podium or lavalier microphone etc.) has its own icon.

Viewing options that reduce the size of the icons make it easier to work with layouts that contain many contribution units. An optional on-screen grid helps with alignment and a snap facility lines up icons with the grid lines. Seat numbers can be automatically assigned to each layout element.

The synoptic layout can be changed simply and quickly. Contribution units can be moved by dragging them using the cursor. Standard Windows functions such as cutting and pasting can be used to move, remove or add elements to the layout.

Control mode

While layout mode is used to create a synoptic floor plan of the conference venue and is therefore for preparation purposes, control mode is used to monitor and control a conference.

The synoptic layout generated in layout mode effectively becomes a control panel in control mode. The icons in the layout become functional, and are used as status indicators or buttons to initiate actions for the contribution unit the icon represents. The colour of a particular icon is related to the state (request-to-speak, active, etc.) of the actual microphone it represents. Icons cannot be moved in control mode, but a layout can always be edited by returning to layout mode. The state of a delegate microphone can be altered by clicking on the appropriate icon.

Synoptic Microphone Control offers the following microphone control mode options:

- Control by operator with request-to-speak list (manual)
- Control by delegate with request-to-speak list (open)
- Control by delegate with override of other delegate microphones (first-in-first-out)

The synoptic layout is stored in a layout file. There are a number of options available to the user for working with these files, all of which are standard DCN file options. These consist of opening, creating and saving files under a new name.

Delegate microphone activity can be recorded on file or sent to a printer. Microphone activity data is also made available for controlling external equipment such as an automatic camera system.

Synoptic Microphone Control has a facility to automatically test and scan all installed microphones individually, with or without a sound generator. The microphone under test is indicated on-screen and the results of the test are made known to the system operator.

Note: the maximum number of icons used without impairing performance when in a multi-CCU configuration is 500.



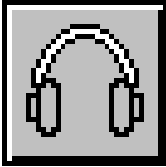

LBB 3572

Simultaneous Interpretation

- Can accommodate up to 90 interpreter desks
- On-line monitoring of interpretation activities
- Facilitates normal and relay interpretations
- Microphone mode options
- On-screen help facility

Multi-language interpretation is an essential component in the international congress venues of today. The Simultaneous Interpretation program supports the preparation of simultaneous interpretation facilities and the monitoring of interpreter activities during a conference. It can accommodate up to 15 interpreter booths, each with up to 6 interpreter desks.

The following options are available:

- Specifying a language for each of the system interpretation channels
- Specifying the languages for outputs A and B of each interpreter desk
- Determining the microphone interlock mode
- On-line monitoring of interpreter activities during a conference

The main window has two display modes, both rich in graphics for easy assimilation of information. One gives a channel-oriented overview of system status, such as which language is present on that channel, the mnemonic for that language, on which language the interpretation is based, and the number of the desk and booth generating that language. The other display mode gives the same information in a different form, providing an overview of the status of each desk in each booth. This includes booth and desk status (active or non-active), and the language in and out of each active desk.

In addition the software enables the operator to establish microphone interlocks, between booths and within booths, with or without using an override facility. In interlock mode, the active microphone must first be turned off before any other microphones can become active. In override mode, any microphone can automatically override the current active microphone and become active.

The interpreter system settings are stored in an interpreter configuration file. There are a number of options available to the user for working with these files, all of which are standard DCN file options. These consist of opening, creating and saving files under a new name.

A print function enables a hard copy printout of desk and channel language assignment - ideal for use as a reference to current system settings.

Note: The maximum number of interpretation channels when used in a single CCU configuration is 15.

Note: The maximum number of interpretation channels when used in a multi-CCU configuration is 11.

Note: When using 15 interpreter channels no intercom channels are available.



Digital Congress Network

Application Modules

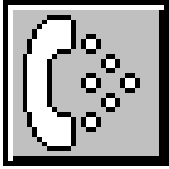

LBB 3573

Intercom

- Enables private, two-way conversations between delegates, chairmen, interpreters and other PC users
- Search facility to locate delegates
- Allows up to 23 simultaneous conversations
- Simple menus for ease of control
- On-screen help facility

The Intercom software module forms the basis of a congress communication system that allows conference participants to hold two-way private conversations. It provides a means of setting up and controlling intercom calls between delegates, chairmen, interpreters and other PC-users during a conference. It allows several types of calls to be made:

- Participant to/from operator
- Between participants
- Interpreter to/from operator
- Between interpreters
- Participant to/from interpreter
- Between PC operators in a multi-PC system

The Intercom software is used in combination with the LBB 3555/00 Intercom Handset and Cradle. It provides assistance in both the pre-conference creation of an intercom network, and the routing and controlling of intercom calls once the conference is underway. Preparation work includes assigning special intercom links between participants, interpreters or both. Once the conference is taking place, the operator can establish and re-route intercom calls via simple on-screen windows.

Note: The number of DCN audio channels available for intercom purposes is set using the System Installation software (LBB 3585). The minimum available number of Hi-Q channels is zero, and the maximum is 12. Each Hi-Q channel can carry two intercom connections, although half of one channel will always be used for the calling tone. Therefore the maximum number of simultaneous calls possible is $24 - 1 = 23$. If no channels are specified for Intercom, the Intercom software module will not start.

Note: Delegate Database LBB 3580 is required if delegate names are used.

Note: Intercom cannot be used when all 15 channels are assigned to interpretations.

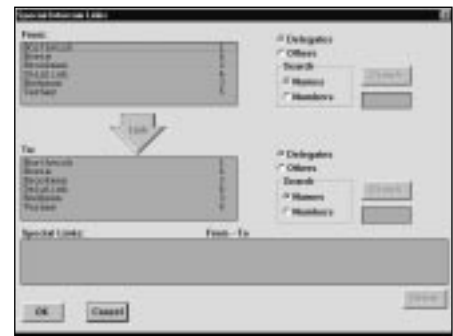

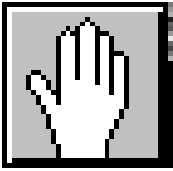

LBB 3575

Parliamentary Voting

- Allows complete operator control of parliamentary voting sessions
- Extensive motion preparation facilities
- Can output voting results to disk, hall displays or printers
- Wide range of vote-related parameter options
- On-screen help facility

The Parliamentary Voting module is a DCN software module designed for controlling and monitoring conferences and discussions using the DCN contribution equipment.

The module allows you to effectively implement and manage voting at a conference. The program covers a number of functions including vote preparation, specifying vote-related parameters, and starting and controlling voting.

The module has two main windows; the Preparation window and the Control window. The preparatory and parameter definition work is mainly carried out from the Preparation window, and the starting and controlling of voting is carried out from the Control window.

The files created using this module are called script files as they act as the script for voting procedures. The file menu allows script files to be opened, created, deleted, saved, saved under a different name, imported and printed out.

A script file consists of a number of votings (between 1 and 9999), each of which is a proposal (or motion) that will be voted on. New votings can be created and existing ones edited within script files. Votings to be edited are selected from a list in the currently open script file and displayed on-screen. All parameters related to this voting can be altered, although certain parameters have to satisfy system-specified criteria. Once a voting has been edited it is inserted back into the list. Every voting must have a unique number, which is used by the DCN system as a reference. The name and description of each voting defines it for both users and delegates.

It is also possible to enable a quorum function. This specifies how many authorized delegates must be present before a voting can legitimately take place. A majority function determines what percentage of votes constitutes a majority voting.

Once a voting is ready to be voted on, it is recalled in the Control window and the voting process is started. When the program enters the active voting state, delegates can use their delegate units to register votes. The user has full control over the voting procedure, and can stop or suspend a vote at any time. Motions that have already been voted on cannot be edited, but voting again on the same motion is possible. It is also possible to vote without opening a script file.

The program offers the possibility of displaying incoming votes or the final result of a vote on hall displays connected to the DCN system, on delegate units with a display facility, and on-screen. It is possible to print out a hard copy of a voting with its results. There is also a facility which automatically prints out the results of a vote once voting is completed.

Note: Delegate Database LBB 3580 is required if delegate names are used.

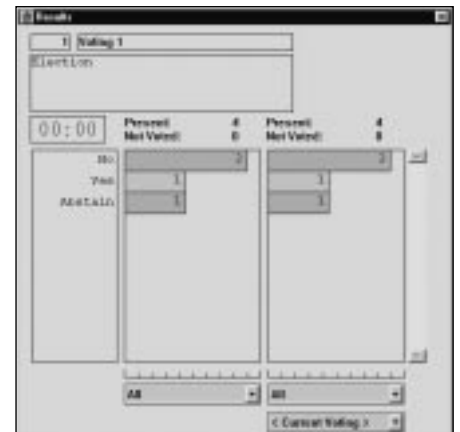

Digital Congress Network

Application Modules

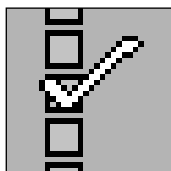

LBB 3576

Multi Voting

- Allows selection between six different kinds of voting
- Extensive voting preparation facilities
- Wide range of vote-related parameter options
- Choice of three voting results display types
- On-screen help facility

This software module provides the user with the means to select and control six different kinds of conference voting, including Parliamentary Voting. The voting types which can be implemented or selected are:

- Parliamentary
- Audience Response
- Multiple Choice
- Opinion Poll
- Rating
- For/Against

In each case, the program allows the user to prepare for voting, specify vote-related parameters, display and print voting results and start and control voting. There are two main windows: the Preparation window and the Control window. The Preparation window is where voting motions are created and parameters are defined or changed. The Control window is used for starting and controlling voting. There is also a Results window for displaying voting results. These can be displayed in bar-, pie- or thermometer chart form. It is also possible to see voting results while the voting is still taking place. These 'interim results' can be specified in the Preparation window. It is also possible to enable a quorum function. This specifies how many authorized delegates must be present before a voting can legitimately take place. A majority function determines what percentage of votes constitutes a majority voting. The files created are called 'script' files as they act as the script for voting procedures. A file menu allows script files to be opened, created, saved, deleted and printed. There is also a facility for importing script files which have been created and saved in another application.

Each script file can consist of a number of voting motions (up to 9999), each of which can be selected from a 'voting motions list' in the Preparation window. Once selected, a voting can be edited and then inserted back into the voting list. All parameters related to the voting can be altered although certain parameters have to satisfy system-specific criteria. A search facility is provided to help locate specific voting motions.

Vote-related parameters can be specified for each individual voting. These are:

- Vote type (open or closed, majority or non-majority, timed or non-timed)
- Time related options
- Results display style
- Interim results display
- Screen and print legends
- Hall display, vote weighting, roll call, voting LEDs and abstain options

Once a motion is ready to be voted on, delegates can register votes on their delegate units. Multi Voting incorporates a roll call function which, when activated, means that delegates must vote in a predetermined order which is specified in the Delegate Database Module (LBB 3580). Otherwise, delegates can vote in any order at the same time. Voting without a script is also possible, and the same functions are available as with a script. Voting can be stopped or suspended at any time, and incoming votes or the final result of a vote can be displayed on hall displays connected to the DCN system, on delegate units with a display facility and on-screen. The user can print the final result of a vote, and it can also be automatically exported to an MS-DOS file.

Note: Delegate Database LBB 3580 is required if delegate names are used.

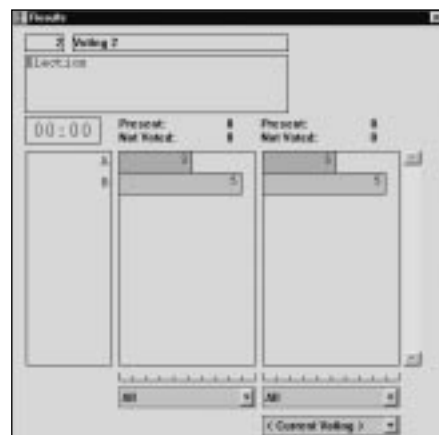
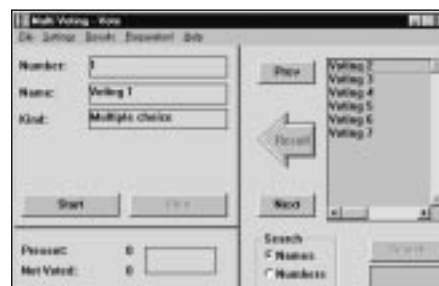

Application Modules

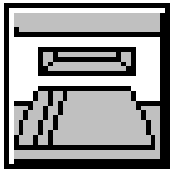

LBB 3578

Attendance Registration and Access Control

- Registration using chip-card with or without PIN-code, or present key
- Access control facilities
- All data instantly available to operator
- Print facility to reproduce data in several formats
- On-screen help facility

The functionality of Attendance Registration falls in to two categories:

Registration: you can specify entrance requirements that conference participants have to meet before entering the conference room. This normally means participants have to insert an chip card in an chip-card reader, either at the entrance to the conference venue or at the contribution unit. Registration at a contribution unit can also be by means of pressing the 'Present' key. You can display lists on-screen of all 'present' and 'absent' participants, and print hard copies of these lists. There is also a window which can be permanently displayed on-screen that gives an overview of all participants who have registered their presence or absence.

Access: the settings specified for registration can also be used for access purposes. This means that although participants can enter the conference venue, they cannot use any of the contribution unit facilities (such as microphone, voting, intercom) without first satisfying access requirements. Access is also controlled by means of chip cards, with or without PIN code. There is also an option whereby participants register their presence at the entrance using an chip-card reader, and a specific contribution unit is then made available for them. You can also control where participants sit by specifying whether they can occupy any seat or a particular, pre-defined one.

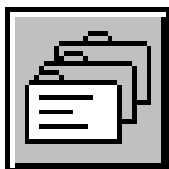
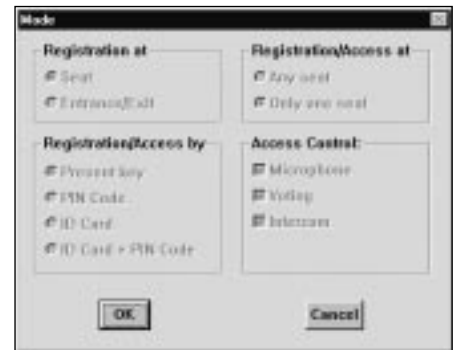
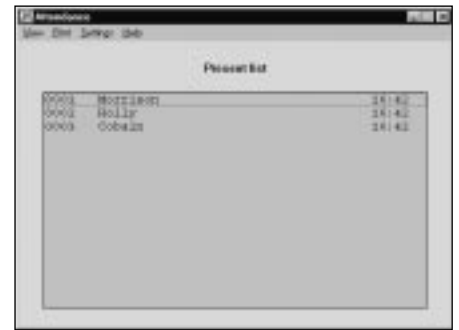

LBB 3580

Delegate Database

- Comprehensive database creation for all delegates
- Facility for configuring 'screen line' and 'card label'
- Facility for printing labels and chip-card production
- Dedicated fields for ease-of-use
- On-screen help facility

The Delegate Database software allows users to compile a comprehensive database of information relating to participants at a conference or meeting. The delegate information is classed as either 'conference-related' or 'personal'.

- Conference-related deals with parameters like interpretation language, vote weight and authorisation. This data is used by the DCN for conference controlling
- Personal information deals with data such as home address and telephone number, date of birth and fax number. This data is for reference only

The data for each delegate is stored in a 'screen card', which contains delegate data in dedicated fields. Screen cards are stored collectively in a names file. There are a number



Digital Congress Network

Application Modules

of options available to the user for working with these files, all of which are standard DCN file options. These consist of opening, creating, deleting and saving files under a new name.

All information is entered via a PC, before or during conference proceedings. A considerable amount of data can be specified for each conference participant. Many parameters are not general but delegate specific, including:

- PIN Code
- Card Code for chip card
- Delegate group
- Delegate country
- Delegate name
- Delegate vote weight
- Delegate seat number
- Language of delegate screen display (French, German, Italian, Dutch, English, Portuguese, Japanese or Spanish)
- Simultaneous interpretation language

If the Card Encoder (LBB 3577/00) and printer are connected to the DCN system, chip-cards can be encoded by using the ID-Card Encoder module, LBB 3581, and the labels for the chip-cards printed.

It is also possible to grant or deny authorisation to individual delegates for the following:

- Microphone
- Voting
- Intercom

This is possible when they use an ID-card to register, and is carried out using the Attendance Registration and Access Control module, LBB 3578.

All delegate data is input via the main window. For some entries (first name, last name) the only restriction is the number of characters entered. For other entries (country, group etc.) the input can easily be selected from a list of options which is presented by the system when the user activates that particular field. This options list can be edited and expanded by the user.

In the personal data section the user can input such delegate data as date-of-birth, address, telephone number, fax and E-mail number. Certain fields within the screen-card can be identified in order to print on an ID-card label, or associated (as a screen line) with other software packages such as Microphone Management and Attendance Registration and Access Control.

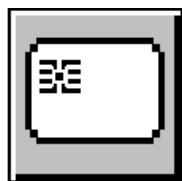

LBB 3581 **ID-Card Encoder**

The ID-Card Encoder software is used in combination with the Delegate Database software (LBB 3580) as a software driver for the production of ID-cards. These ID-Cards can be used to identify delegates during a conference and contain information specified using Delegate Database. An encoding unit (LBB 3577/00) is also required to produce the ID-cards.

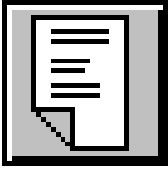

LBB 3582

Message Distribution

- Message distribution to personal or hall displays
- Easy message generation procedure
- Archiving facility allows messages to be retrieved and re-used
- Automatic message removal option
- On-screen help facility

The Message Distribution software allows the operator to originate messages which can be sent via the DCN to individual delegates, groups of delegates and other participants to view on their units. Messages can also be sent to hall displays for general viewing by the public and delegates. Messages created can be stored in a library for later use. There is a facility that automatically removes messages after they have been displayed for a pre-specified period of time. The Message Distribution software can be used in combination with the Video Display software (LBB 3584) and the Text/Status Display software (LBB 3583).

Note: Message text is only available on delegate units with display.

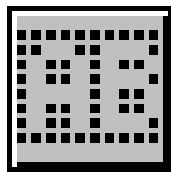
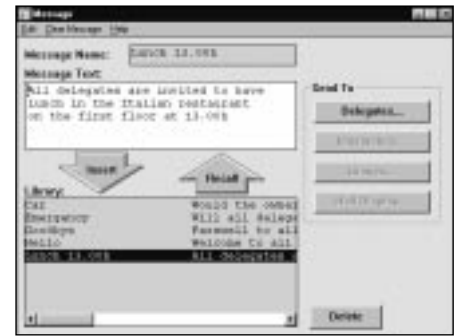

LBB 3583

Text/Status Display

- Supports numeric, alphanumeric and geographic displays
- Displays voting, message and microphone information
- Automatic priority system for displays
- Accepts information from other DCN software modules
- On-screen help facility

The Text/Status Display module provides a means of displaying conference-related information on character displays located in the conference venue. Almost all the information displayed is generated by other DCN modules. The text that appears on screen to accompany voting results can be generated using Text/Status Display. It is also possible to specify the display length of the speakers list and the request-to-speak list.

Text/Status Display accepts three different types of display information:

- Voting Results display. This information is generated using the Parliamentary Voting module (LBB 3575) and consists of a voting motion (number, description, time) and the results of the vote on that motion
- Messages display. This information is generated using the Message Distribution (LBB 3582) and consists of a conference-related text message
- Microphone Information display. This information is generated either using the Microphone Management module (LBB 3570) or the Synoptic Microphone Control module (LBB 3571). It consists of a list of delegates whose microphones are active and those waiting to speak

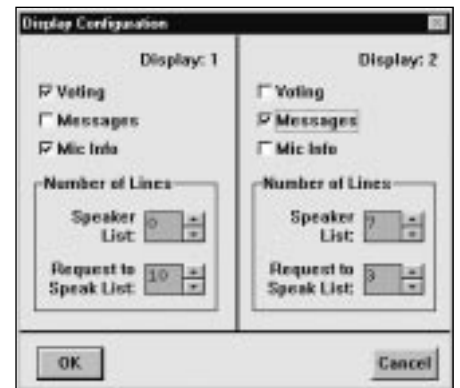

Digital Congress Network

Application Modules

This software supports three different types of conference venue displays:

- Numeric display. This is typically a dot matrix display of only a few characters per line, and allows only purely numerical information to be displayed
 - Alphanumeric display. Also typically a dot matrix display, but for up to 10 lines of 33 characters. Information can be displayed using both text and numbers
 - Geographic or status display. This kind of display gives information on the voting status of each conference participant (if the vote is non-secret). A representation of the seating plan and different coloured LEDs for vote status are used to achieve this.
-

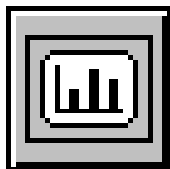

LBB 3584

Video Display

- Interface to monitors, video projectors and Vidiwalls
- Displays voting, message and microphone information
- Import facility for graphics such as logos and backgrounds
- Accepts information from other DCN software modules

Video Display is unlike all other DCN modules in that there is no user action required to operate it. It carries out its function - interfacing the DCN software with video displays - automatically. It provides a means of displaying conference-related information on video displays located in the conference venue. The information can consist of text, numbers and graphical elements like bar charts. All the information displayed is generated by other DCN modules, and it is not possible to alter this information in Video Display.

To use Video Display, it is necessary to have a Video Display (VD) Client application. The VD Client application receives the information which is passed to it from the Video Display (server) module. The user can change settings related to how information is displayed on the video screens, such as text or background colours. This can be carried out either during or after installation of Video Display. The VD Client application is supplied with the DCN installation disks.

This VD Client application accepts four different types of display information:

- Voting Results display. A voting motion and the results of the vote on that motion.
- Message display. A conference-related text message (e.g. when and where lunch will be, or when tomorrow's session will begin).
- Microphone Information display. A list of delegates whose microphones are active and those waiting to speak.
- Attendance registration display. Information about how many delegates are absent or present.

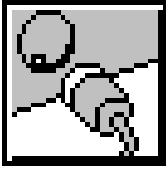

LBB 3585

System Installation

- Single-point control of system installation
- Facilities for assigning functions to audio channels
- Automatic seat numbering
- Facility for downloading font sets
- In-conference warning message when installation configuration changes
- On-screen help facility

The System Installation software is a powerful and effective tool for installers and system operators when installing and setting up the DCN system. System installation, set-up and functions are brought entirely under PC control through its easy-to-use, Windows-based software.

The DCN System Installation software provides - in an easy yet methodical way - the means to assign seat numbers to microphone units and to specify the number of audio channels dedicated to interpretation, floor and intercom facilities.

Assigning seat numbers

The initial task in any installation is to assign seat numbers to delegate contribution units. The System Installation software makes the task easy with a choice of two assignment methods:

- (1) From the hall, by physically pressing delegate microphone buttons in sequence.
This is registered by the PC which in turn automatically allocates the unit a number.
- (2) From the PC, where the operator selects a random microphone and allocates a number.
The next assigned number will follow on sequentially. The software instantly recognises when a new unit is installed by offering a seat number for the newly installed unit.

A dialogue box displaying the system configuration is available at any time, with the total number of installed delegate and chairman units, interpreter desks etc.

Downloading font sets

It is possible to download special font sets that allow certain DCN contribution units to display characters in complex European languages, or icon-based scripts such as Chinese.

Audio channel assignment

The DCN system offers in total 16 audio output channels, with a default configuration of 15 distribution and 1 communication channel. Twelve distribution channels can be assigned to combinations of interpretations, floor language and intercom, with two channels reserved for line output and one for delegate loudspeakers as default. If required, these three extra channels can also be used for interpretations.

All channel assignments are interdependent. The number of channels assigned to floor and intercom is dependent on the number required for simultaneous interpretation.

In large international conferences using 15 interpretation channels plus one floor channel, a channel is automatically assigned to interpreter intercom use. In such a case the system performs totally as an interpretation system.

Note: All distribution channels are available via the Audio Media Interface Unit LBB 3508. The line output on the central control unit always provides a floor signal which is the sum of all active microphones.

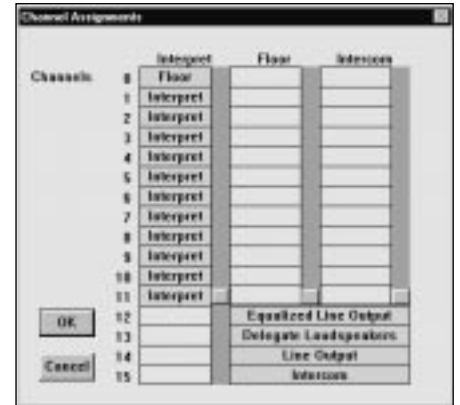
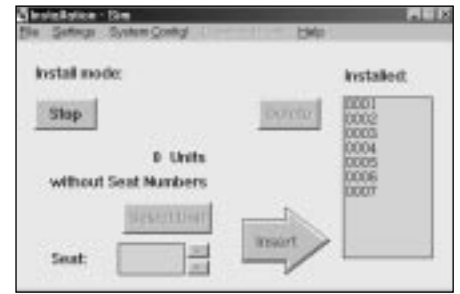

Digital Congress Network

Application Modules and Multi-CCU Control Software

The task of assigning audio channels is made easy with the aid of on-screen channel selection, using a display with three scroll bars that gives an instant overview of all channel allocations and the effect of altering any of these allocations.

System Installation is primarily a preparation program. Once all microphones and delegate units have been assigned seat numbers and the audio channels configured and tested, there will be no need to use System Installation for day-to-day monitoring and controlling of a conference. However, if the physical layout changes in the conference hall (delegate units are added, for example) then the data in System Installation must be updated, and a message immediately appears in the installation window.

The conference-related information generated is stored in an installation file. The user can open, create, save, delete and save these files under a new name.

Note: the maximum number of interpretation channels when used in a multi-CCU configuration is 11.

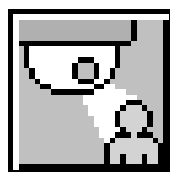

LBB 3588 and LBB 3562 DCN Automatic Camera Control

The DCN Automatic Camera Control software is designed to interface DCN congress systems with the Philips Allegiant series of video control switchers. It selects fixed or pre-positioned cameras (such as the Philips dome models) to be activated to display the current active speaker at a conference. When a chairman or delegate microphone is activated on the DCN equipment, the camera assigned to that position is activated. When no microphones are active, an overview camera is automatically selected. The image can be displayed on hall displays or other monitors together with information about the current speaker if required (such as delegate identification). The system operator has a monitor, which also displays information about which camera is active. This system provides an extra dimension to congress and conference proceedings. Up to 1500 delegate positions can be covered using a maximum of 256 cameras.

There are two versions of DCN Automatic Camera Control software available:

- LBB 3588 is for DCN systems with a CCU and a control PC. The activation and installation of the cameras is integrated into the DCN PC control software.
- LBB 3562 is for stand-alone DCN systems (systems without PC control).

LBB 3586 Multi-CCU Control Software

The Multi-CCU control software is a dedicated program that allows the user to set up and monitor congress systems that use more than one Multi-Central Control Unit (CCU). Multi-CCU software allows up to 32 Multi-CCUs to be interconnected in a single system. The user can select up to eight of these Multi-CCUs for use at any one time, and then specify a number of parameters related to the control of these CCUs.

Multi-CCU software is used for conferences with more than 240 delegates, or situations where it is advisable to connect groups of contribution units to separate CCUs (i.e. in multi-hall conference venues). It runs under the OS/2 operating system on a dedicated PC.

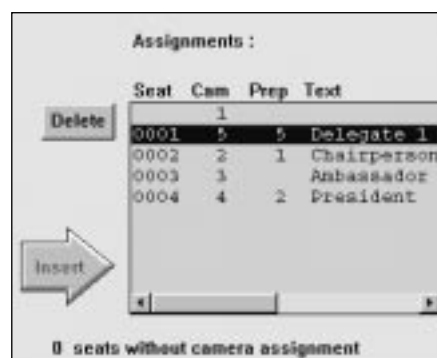
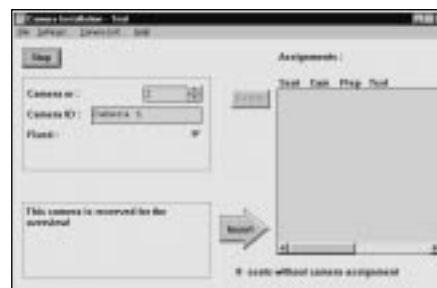

Multi-CCU Control Software and Open Interface software

There are a number of possibilities available with the Multi-CCU software:

- Specifying which CCUs will be required for a conference, before the conference begins. This information is stored in a configuration file
 - Loading, preparing and editing configuration files. This includes assigning new names to CCUs, specifying which CCUs will be active in a conference and specifying the default CCUs for 'Audiomaster', 'Control PC' and 'Interpreters'
 - Monitoring Multi-CCU behaviour. Warning messages are displayed whenever there is a change in the actual configuration or when a power failure occurs while using an Uninterruptible Power Supply (UPS)
-

LBB 3587

Open Interface software

The DCN Open Interface software allows remote control of selected DCN functions via third party equipment and control software. Control data exchange between DCN and the remote control device or system is carried out via an RS232 port on the CCU. Access to the CCU for remote control is opened with the Open Interface software via a PC connection to the serial port of the CCU. Possible DCN functions for remote control are:

- System Configuration
- System Installation
- Microphone Management
- Parliamentary Voting
- Attendance Registration

Remote control is only possible with the LBB 3500/15 and LBB 3500/35 (in single CCU mode) CCUs, and the master CCU PC (with OS/2 and PC-card LBB 3511/00) in multi-CCU systems. For detailed information, refer to the LBB 3587 Open Interface software documentation.

Digital Congress Network

Digital Congress Network

Overview

Introduction

A flexible and versatile display system is an important aid in distributing information in conference venues. Philips information displays provide a quick and effective means of informing participants and audience of the status of events such as congress arrangements, room allocation, changes in the agenda, advertising spots, interpretation distribution, microphone status, voting information and results, and up-to-date news.

Within this range of information displays are products to match the requirements of almost any conference, from small scale informal discussions to large-scale international multi-lingual congresses.

Personal displays

The basic DCN information display system is housed in a delegate contribution unit and consists of a 2-line, 40-character LCD display for displaying text messages. These displays can display information generated by DCN software modules as well as text to describe the contribution unit soft key functions.

LCD technology has also been applied in the development of compact displays which can be built into table-tops or the backs of seats, providing an ideal solution for personal information presentation to selected delegates or groups of delegates or interpreters. These displays offer an ideal and unobtrusive solution for the display of any live or recorded video material, adding a valuable extra dimension to delegate information facilities connected to a separate cable system.

Hall displays

Hall displays are the ideal medium with which to impart information clearly and effectively to a large number of conference participants. Numeric, alphanumeric and geographic displays are available, and are mainly used for displaying voting results and other text and conference-related data. Also direct view or front or rear projector video displays can be used e.g. TV receivers, Video projectors are ideal for large audiences or longer distance viewing. These systems allow high-quality display of any live or recorded video material as well as computer generated graphics and text.

DCN information displays

Hall Displays			
	Description	Comments	Page:
	Numeric hall display	Dot matrix display	6.2
	Alphanumeric hall display	Dot matrix display for numbers and text	6.2
	Geographic display	LED display modules	6.2
Accessories			
LBB 3512/00	Data distribution board	Drives hall display	6.2



Digital Congress Network

Hall Displays

Numeric Hall Display

This dot matrix display with its own built-in power supply unit is used in DCN systems to display voting results and remaining voting time. Legends can be fixed to the screen to accompany and clarify the numeric display. These would typically be 'TIME', 'PRESENT', 'FOR', 'AGAINST', 'ABSTAIN' and 'NOT-VOTED'.

This display can be supplied ready-for-use including an installed Data Distribution Board LBB 3512/00.

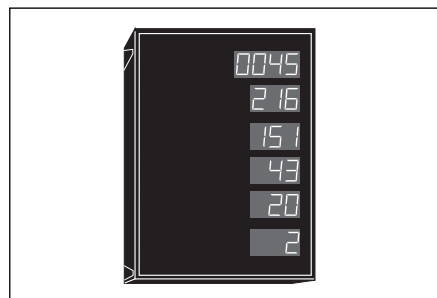

Alphanumeric Hall Display

This dot matrix display with its own built-in power supply can display both numbers and text, and can therefore be used for showing microphone information (speakers list or request-to-speak list), voting results and motion information and messages. This information is generated in the relevant software modules and sent to the hall display via the Text/Status Display software module (LBB 3583). The Alphanumeric Hall Display can be supplied ready-for-use including an installed Data Distribution Board LBB 3512/00. The recommended number of lines is 10 and the number of characters per line is 33.

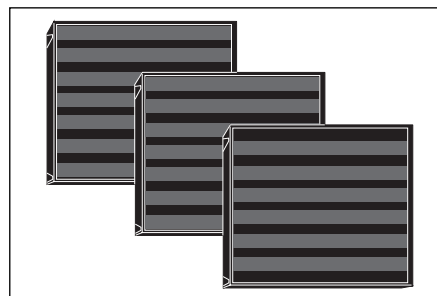

Geographic Hall Display

The screen of this hall display is built-up using LED modules and is designed to show individual voting results. Each contribution unit in the conference venue is represented by three different coloured LEDs which show how each delegate has voted ('YES', 'NO', 'ABSTAIN'). The layout of the display can be either according to the seating arrangement (synoptic) or according to a list showing delegate names and/or country. The geographic display can be supplied ready-for-use including an installed Data Distribution Board LBB 3512/00. Information on connection to the DCN system is available on request.

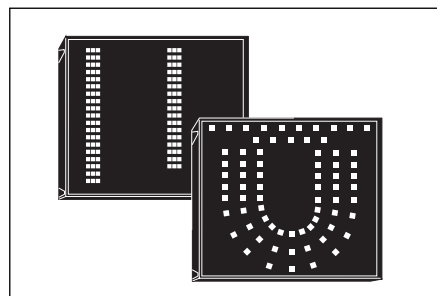

LBB 3512/00

Data Distribution Board

- Drives hall displays
- Allows transparent data transport for remote control of external equipment

The LBB 3512/00 is a printed circuit board which is used with digital equipment such as hall displays, recorder systems and camera controllers to provide the data communication link to the DCN. Transparent data transport between data communication boards in the DCN system is possible, i.e. for remote control of slide projectors, lights, blinds, projection screens etc. It is intended for mounting in external equipment, and includes an RS232 communication port with a baud rate of 9600 or 1200 baud - selectable by an on-board dip switch. Opto-couplers isolate it from the DCN system. It can be powered by DCN system supply or an external power source.

Controls and Indicators

- Initialisation button with LED indication

Interconnection

- 2 m (78.7 in) cable terminated with a moulded 6-pole circular connector
- Multi-pole PCB connector for:
 - external initialisation button and LED
 - 8-bit parallel data input and output
- 9-pole D-sub socket for RS232 output

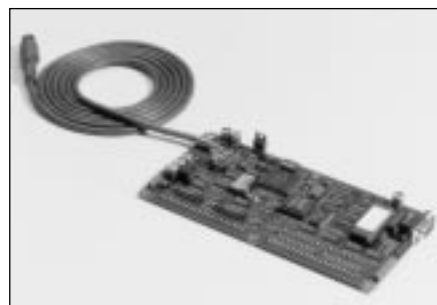

Technical data

External supply	7.5 - 35 Vd.c.
Dimensions (H x W)	100 x 200 mm (3.93 x 7.87 in)

Digital Congress Network

Overview

Introduction

Transfer and exchange of information is a vital element in conferences, from small informal gatherings to international multi-lingual congresses with hundreds of delegates. Audio systems have traditionally been at the heart of conferences, because a basic requirement of such a gathering is that all present can clearly hear what is being said, in a language they understand. But with increasing sophistication in congress management, it is now possible to incorporate visual elements, thus adding an extra dimension to conference proceedings.

There is an extremely wide range of visual aids suitable for use with the DCN system. The most basic include overhead projectors and slides. Then there are televisions, monitors and large screen video projectors, using pre-recorded video tapes and cassettes and TV camera pictures. But it has been the use of the personal computer, presentation software, the laser disc, advanced LCD technology and CCDs for colour TV cameras that has revolutionised visual presentation and turned it into an indispensable part of effective congress management. Ever

decreasing prices of the new technology has also made sophisticated visual presentation a reality for congresses and conferences of all sizes.

This visual equipment, combined with the facilities offered by the Philips DCN, offers each type of congress venue the possibility to fulfil even the most demanding wishes of their customers. The fully digital DCN combines excellent audio quality with a wide range of visual presentation possibilities. Many integral conference management functions, such as voting information and results, messages and microphone status can be displayed in the conference venue. The type of display used, such as video projector, TV or monitor, depends on the number of people who have to access the information.

Video cameras are also widely used in many venues. They can show delegates in a congress venue and allow both internal viewing and external distribution to broadcasting organisations. Special cameras called visualizers or imagers are available for displaying documents and

objects. All these cameras have a flexibility that enables them to be used in venues ranging from small meeting rooms to parliaments and large commercial congress venues.

Video cameras are always combined with video switching facilities and in many cases with camera control systems. For distribution of video and audio signals to video display equipment, distribution amplifiers or an MATV-system are often required. Video recording equipment for recording and playback purposes is used in almost all applications. Editing equipment is indispensable if recorded meetings require post production to create video cassettes for archiving distribution among meeting participants and for promotional purposes.

This section contains a summary of Philips products suitable for use as video elements in a DCN system. Philips also supplies many more own-brand and third-party products for this purpose. For more information, please contact your local Philips representative.

Allegiant Video Switchers	Comments/description	Page
LTC 8200 Series	Video switcher control system	7.2
LTC 8555 Keyboard	Allegiant keyboard with joystick	7.3
Dome systems		
LTC 0829 Series	Compact, lightweight dome system	7.4
Cameras		
LTC 0450 Series	Colour camera	7.5
Monitors		
LTC 2917/90	17-inch colour monitor	7.6
LTC 2814	14-inch colour monitor	7.6

Digital Congress Network

Allegiant Video Switcher System

The DCN can operate with a range of Allegiant Video Switchers. These units are used in combination with Allegiant Keyboards and the DCN Automatic Camera Control software to configure a camera switching system. This ensures that speaking delegates are always displayed on the hall displays. An outline is given below of the Allegiant Video Switchers available. The LTC 8200 is recommended for DCN. This allows up to 16 camera to be connected, and has five video outputs. Information about other Allegiant Video Switchers and CCTV equipment can be found in the Philips CSS Security Surveillance Data Book and relevant data sheets.

LTC 8200

Allegiant Video Switcher

- 16 camera inputs and five video outputs
- Control of AutoDome[®] Series dome cameras
- 48-character on-screen display
- Compact single bay construction

The LTC 8200 Allegiant Video Switcher offers a powerful way of providing automatic camera switching in conference venues. It can be easily configured using the DCN Automatic Camera Control software, and an Allegiant Keyboard. It then ensures that cameras are automatically switched to cover the speaking delegate in conferences.

The LTC 8200 has 16 video inputs for connecting cameras. Either fixed or dome cameras can be connected. There are also five video outputs used to connect hall displays or monitors. Up to four Allegiant Keyboards can be connected. This makes the LTC 8200 the ideal solution for today's conference needs.

Interconnection

- BNC Video inputs and monitor outputs
- Console, RS232 port for external PC or control interface (CCU of DCN system) - 9-pin D-type connector
- Biphase out, Multiple ports (12 for LTC 8200) for camera control - removable screw terminal connection blocks.
- Keyboards, Multiple ports (4 for LTC 8200) for keyboard connection - 6-pin RS485 ports for Allegiant Keyboard use.



	LTC 8200/50	LTC 8200/60
Rated voltage	220 to 240 Va.c. (50/60 Hz)	120 Va.c. (50/60 Hz)
Voltage range	198 to 264 Va.c.	100 to 140 Va.c.
Power consumption	50 W	50 W
LTC 8200/50 and LTC 8200/60		
Video input signal	0.5 V _{pp} to 2 V _{pp} (composite negative sync.)	
Gain	Unity ± 2 % (75 W)	
Video bandwidth (-3 dB)	25 MHz	
Dimensions (W x D x H)	440 x 305 x 40 mm (17.3 x 12 x 1.7 in)	
Weight	4 kg (8.8 lb)	
Mounting	Rack mounting brackets included	

Overview of Allegiant Video Switchers available

Type number	No. of video inputs	No. of video outputs	Max. No. of keyboards
LTC 8100	8	2	2
LTC 8200	16	5	3
LTC 8300	32	6	4
LTC 8500	64	8	8
LTC 8600	128	16	16
LTC 8800	256	64	32

Digital Congress Network

Allegiant Video Switcher System

LTC 8555/00

Allegiant Keyboard

- Full-function, ergonomically-designed keyboard
- Variable speed joystick control
- 48-character on-screen display

The LTC 8555/00 Allegiant Keyboard is used with the LTC 8200 Allegiant Video Switcher. It provides a convenient means of operating and configuring the switcher. It is equipped with a variable-speed pan and tilt joystick control for positioning cameras, and also has an attractive screen for displaying camera information. The Allegiant Keyboard and Allegiant Video Switcher are used with the DCN Automatic Camera Control software. A range of Allegiant Keyboard accessories is available, including a keyboard extension cable, keyboard extension kit and keyboard rack mount kit. Refer to the Philips CSS Security Surveillance Data Book for more information about keyboards and accessories.



Technical Data	
Dimensions (W x D x H)	220 x 51 x 155 mm (8.7 x 2 x 6.11 in)
Weight	0.55 kg (1.2 lb)

Digital Congress Network

Dome Systems

Dome System

The LTC 0829 Series AutoDome System allows total observation of a large area with a single camera system. The system, with its built-in camera, driver and integral high-speed pan and tilt, provides 360° observation. It is possible to program the system with up to 99 prepositions.

LTC 0829 Series

AutoDome System

- Integral camera pan/tilt and receiver/driver system
- 360 degrees observation
- High-speed pan/tilt operation
- Up to 99 prepositions

The Philips LTC 0829 Series AutoDome System is ideal for conference venues. Its powerful auto-focus zoom lens allows it to produce clear, close-up shots of speaking delegates, in all sizes of congress venue. The high-speed pan-tilt operation means it can quickly switch positions, and the 360° angle of operation means all seating positions can be covered. It is comprised of a camera/lens module, a backbox/power supply module and a dome module.

The dome system is a compact, lightweight system containing a high-performance 1/3-inch colour CCD camera with a 16:1 auto-iris, auto-focus zoom lens. Additional zoom power is provided by a 6.25 x digital electronic zoom. Integral high-speed pan/tilt and variable speed operation allow accurate, high-speed camera positioning. The camera, lens and pan/tilt module can easily be removed from the domed enclosure to simplify installation and service. The cameras can be mounted in either suspended or in pendant mount.

The camera/lens modules are available in two versions, the LTC 0829/18 and LTC 0829/19 PAL B and the LTC 0829/28 and LTC 0829/29 NTSC.



	LTC 0829/1x	LTC 0829/2x
Camera type	high-resolution colour	high-resolution colour
Control	biphase or RS232	biphase or RS232
TV standard	PAL B	NTSC
Lens	4.5 to 72 mm	4.5 to 72 mm
Power	21 to 28 Va.c.	21 to 28 Va.c.
Clear bubble	LTC 0829/19	LTC 0829/29 (complete assembly)
Tinted bubble	LTC 0829/18	LTC 0829/28 (complete assembly)

The recommended power supply is the TC220 PSX-24

For more information, refer to the Philips CSI Security Surveillance Data Book.

Digital Congress Network

Cameras

LTC 0450 Series

Digital Colour Cameras

- High-resolution colour images
- 1/3-inch format CCD imager
- Available in PAL and NTSC versions

The LTC 0450 Series are the ideal camera for use as the fixed position overview camera in conference applications. They deliver sharp, high-quality colour images that can be displayed during the movement of the dome camera. Enhanced picture quality, realistic colour reproduction and outstanding reliability make them an excellent choice for professional applications.

All versions offer high-sensitivity, high-resolution images, and their excellent reproduction is supported by automatic white balance and back-light compensation.

The LTC 0450/51 conforms to the PAL standard, while the LTC 0450/61 conforms to NTSC. Both cameras can be used over a wide range of mains supplies for flexible installation (low voltage cameras are also available). They are also equipped with a standard CS-mount for use with a wide variety of lenses.

The following accessories are available for the LTC 0450 series:

- LTC 3361/30 - Varifocal 3.5 to 8 mm manual lens
- LTC 3364/31 - Varifocal 3.5 to 8 mm auto-iris lens



	LTC 0450/51	LTC 0450/61
Sensor	1/3 inch interline	1/3 inch interline
TV standard	PAL	NTSC
Resolution	450 TV lines	450 TV lines
Sensitivity (usable picture)	1.5 lux (F1/2)	1.5 lux (F1/2)
Shutter speed	automatic 1/60 to 1/100,000 s	automatic 1/60 to 1/100,000 s
Video output	1.0 V _{pp} into 75 Ω	1.0 V _{pp} into 75 Ω
Power supply	85 to 264 Va.c. (50 Hz)	85 to 132 Va.c. (60 Hz)
Power consumption	5 W	5 W
Lens mount	CS-mount	CS-mount
Dimensions (L x W x H)	121 x 68 x 49 mm (4.76 x 2.68 x 1.93 in)	121 x 68 x 49 mm (4.76 x 2.68 x 1.93 in)
Weight	0.49 kg (1.1 lb)	0.49 kg (1.1 lb)
Lens type	fixed iris, manual iris, DC-iris and video iris	fixed iris, manual iris, DC-iris and video iris

Digital Congress Network

Monitors

LTC 2917/90

High-Resolution Colour Monitor

- Ideal for DCN Automatic Camera Control application
- High-quality images

The LTC 2917/90 is a versatile 17" colour monitor that offers a high quality option for conference camera applications. It can be used as operator display with the DCN Automatic Camera Control software. The monitor conforms to NTSC, PAL and S-video standards.

Located on the front are controls for volume, colour, standard tint, contrast and brightness. Monitor adjustments can also be made via user-friendly on-screen menus. The monitor is housed in a compact, space-saving metal cabinet.



LTC 2917/90	
TV standard	PAL/NTSC, Auto select
Tube type	17" (44 cm) diagonal, 90° deflection, in line guns, stripe pitch 0.42 mm (0.02 in)
Screen size	16" (41 cm) measured diagonally
Resolution	550 tv lines or more
Video input	Video A: Composite video - BNC x 2, 1 V _{pp} 75 Ω Video B: Composite video - BNC x 2, 1 V _{pp} 75 Ω Video B: Y/C-separated - 1 line, mini-DIN 4-pin connector x 2
Power supply	120/230 Va.c. 50/60 Hz
Power Consumption	140 VA
Dimensions (H x W x D)	334 x 395 x 420.5 mm (13 x 15.5 x 16.5 in)
Weight	17.2 kg (38 lb)

LTC 2814

High-Resolution Colour Monitor

- Ideal for DCN Automatic Camera Control application
- High-quality images

The LTC 2814 is a versatile 14" colour monitor that offers an easy-to-install, cost-effective option for conference camera applications. It can be used as operator display with the DCN Automatic Camera Control software. The monitor is available in two versions. The LTC 2814/90 is PAL/NTSC compliant.

Located on the front are controls for tint, colour brightness and contrast. The monitor is housed in an attractively styled case, and can be used as a desktop unit or rack mounted.



LTC 2814	
TV standard	LTC 2814/90 - PAL/ NTSC
Tube type	14" diagonal (35 cm), 90° deflection, in line guns, stripe pitch 0.63 mm (0.02 in)
Screen size	14" (35 cm) measured diagonally
Resolution	350 tv lines (CVBS), 400 tv lines (Y/C)
Video input	Composite video: 0.5 to 2.0 V _{pp} , sync. negative. Automatic switching from 75 Ω unbalanced termination to Hi-Z with looped-through operation. Y/C: Impedance: 75 Ω unbalanced, Y signal: 0.7 V _{pp} , C signal: 0.3 V _{pp}
Power supply	100/240 Va.c. 50/60 Hz
Power Consumption	65 W
Dimensions (H x W x D)	330 x 353 x 390 mm (13.0 x 13.9 x 15.3 in)
Weight	14 kg (30.8 lb)

Cables and Accessories

Introduction

The range of DCN installation accessories allows system installation to be greatly simplified by the use of ready-made cables with connectors. Trunk-cable splitters allow trunk lines to be split and run in diverse directions, which means contribution units can be located precisely where they are required in a conference venue. DCN installation accessories are used for both fixed and portable installations.

LBB 3514/00

Trunk-Cable Splitter

The LBB 3514/00 is used in conjunction with the system installation cabling to divide the trunk-line cabling, thus allowing system installers to achieve the optimum layout of the trunk-line, and therefore contribution equipment, to suit the conference venue. The trunk-cable splitter comes complete with cable restraining clamps and includes mounting holes for fixing to a floor or wall.

Interconnection

- 2 m (78.74 in) long cable terminated with a moulded 6-pole circular connector
- 6-pole circular connector for loop-through connections
- 2 x 6-pole circular connector for trunk cable splitting and pulse regeneration purposes

Technical data

Dimensions (H x W x D)	35 x 49 x 140 mm (1.37 x 1.91 x 5.51 in)
Weight	approx. 0.3 kg (0.66 lb)
Colour	charcoal (PH 10736)



LBB 3515/00

Tap-Off Unit

The LBB 3515/00 is used to create short-circuit proof tap-off points on the trunk-line cabling. Each tap-off point allows for connection of up to four channel selector panels or up to two table-top contribution units such as delegate-, chairman- or interpreter desks. A Tap-Off Unit consists of two tap-off points. The Tap-Off Unit comes complete with cable restraining clamps and includes mounting holes for fixing purposes.

Interconnection

- 2 m (78.74 in) long cable terminated with a moulded 6-pole circular connector
- 6-pole circular connector for loop-through connections
- 2 x 6-pole circular connector for tap-off purposes. Each tap-off is equipped with an electronic short-circuit protection facility on the power supply lines

Technical data

Dimensions (H x W x D)	35 x 49 x 140 mm (1.37 x 1.91 x 5.51 in)
Weight	approx. 0.3 kg (0.66 lb)
Colour	charcoal (PH 10736)



Digital Congress Network

Cables and Accessories

LBB 3516/xx

Extension Cable Assembly

Cable terminated at both ends with a moulded 6-pole circular connector (male and female). The extension to the type number gives the length of the cable.

Technical data

Grey PVC sheath	6 mm (0.24 in) dia.
-----------------	---------------------

Ordering information

LBB 3516/02	2 m (78.74 in) length
LBB 3516/05	5 m (196.85 in) length
LBB 3516/10	10 m (393.70 in) length
LBB 3516/15	15 m (590.55 in) length
LBB 3516/20	20 m (787.40 in) length
LBB 3516/25	25 m (984.25 in) length



LBB 3516/00

100 m Installation Cable

100 m (328 ft) roll of cable identical to LBB 3516/xx but without connectors.

LBB 3517/00

Set of 25 Cable Locking Clamps

Matching clamps for male/female cable connectors such as those on the Extension Cable LBB 3516/xx. One clamp per male/female connector required.

Digital Congress Network

Technical Data

Conforming to the international standard IEC 914; Conference systems - electrical and audio requirements.

9.1 Microphones

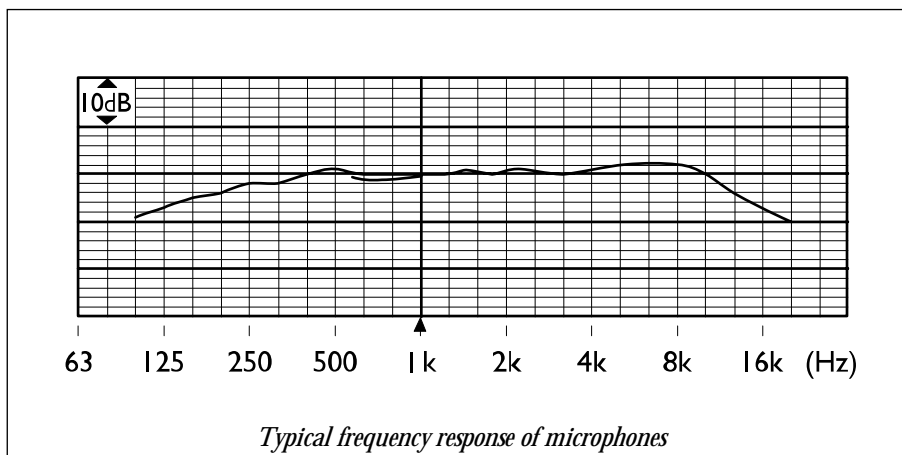
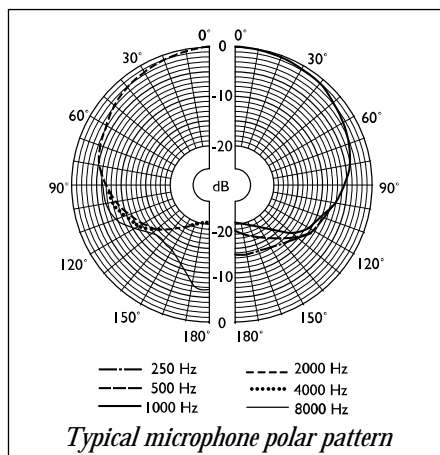

General	
Frequency response	100 Hz to 16 kHz
Transducer type	condenser
Directional pattern	cardioid
Max. SPL for THD <3%	110 dB
Equivalent input noise level	24 dB (A)

9.2 Headphones

Dynamic Headphones LBB 3440/00	
Impedance	300 Ω
Frequency response	80 Hz to 15 kHz (-10 dB)
Power handling capacity	100 mW
Sensitivity (1 kHz)	87 dB SPL/earpiece at 0 dBV/system (85 dB SPL/earpiece at 1 mW/system)
Weight	84 g (0.19 lb)
Colour	black

Under The Chin Headphones LBB 3441/00	
Impedance	300 Ω
Frequency response	50 Hz to 5 kHz (-10 dB)
Power handling capacity	60 mW
Sensitivity (1 kHz)	107 dB SPL/earpiece at 1 mW/system
Weight	33 g (0.07 lb)
Colour	black

Digital Congress Network

Technical Data

LBB 3442/00 Single Earphone	
Impedance	32 Ω
Frequency response	100 Hz to 5 kHz (-10 dB)
Power handling capacity	5 mW
Sensitivity (1 kHz)	114 dB SPL at 1 mW/system
Weight	25 g (0.06 lb)
Colour	dark grey

Dynamic Headphones LBB 3015/04 and LBB 9095/30	
Impedance	360 Ω (LBB 9095/30 2 x 720 Ω)
Frequency response	250 Hz to 13 kHz (-10 dB)
Power handling capacity	200 mW
Sensitivity (1 kHz)	97 dB SPL/earpiece at 0 dBV/system, 96 dB SPL/earpiece at 1 mW/system
Weight	90 g (0.19 lb)
Colour	black/grey

9.3 Transmission links

- From delegate microphone to interpreter headphone
- From delegate microphone to delegate headphone
- From interpreter microphone to delegate headphone
- From interpreter microphone to interpreter headphone
- From auxiliary input to delegate headphone
- From auxiliary input to interpreter headphone
- From delegate microphone to auxiliary output
- From interpreter microphone to auxiliary output

General	
Frequency response	125 Hz to 14 kHz *
Harmonic distortion	<0.5%
Harmonic distortion at overload	<1%
Crosstalk attenuation at 4 kHz	>80 dB
Dynamic range	>90 dB
* intercom links	125 Hz to 3.5 kHz

9.4 Combined units

- Delegate microphone with transmission link to interpreter headphone
- Delegate microphone with transmission link to delegate headphone
- Delegate microphone with transmission link to auxiliary output
- Interpreter microphone with transmission link to interpreter headphone
- Interpreter microphone with transmission link to delegate headphone
- Interpreter microphone with transmission link to auxiliary output

General	
Typical frequency response	125 Hz (-8 dB) to 14 kHz (-8 dB)
Front-to-random sensitivity index	>4.6 dB
Rated equivalent sound pressure level due to inherent noise	<25 dB (A)
Total harmonic distortion at overload	<1%
Crosstalk attenuation	>80 dB

Digital Congress Network

Technical Data

9.5 System electrical and electro-acoustic characteristics

General	
Nominal input level	85 dB SPL
Overload input level	110 dB SPL
Automatic gain reduction at overload input level (not for PA-floor output)	30 dB (interpretation channels, 18 dB (delegate loudspeaker channel))
Automatic gain reduction with	
- 2 microphones on	3 dBm
- 4 or more microphones on	6 dBm
Operator master gain control	15 x 1 dB and OFF (Mute)
Loudspeaker gain control	14 x 1 dB and OFF

9.6 System environmental conditions

General	
Working conditions	fixed/stationary/transportable
Temperature range	
- transport	-20 to +55 °C (-4 to 131 °F)
- operating*	+5 to +45 °C (41 to 113 °F)
*Note: For LBB 3506 and all contribution units with LC-Displays, the maximum is +40 °C (104 °F)	
Relative humidity	95% max.
Safety	according to EN 60065, and according to CAN/CSA-E65-94 (C and US) and UL 6500-96 for LBB 3500/xxD, LBB 3506/00D and LBB 3508/00D
EMC emission	according to harmonised standard EN 55013 (1988) and FCC rules (part 15) complying with the limits for a class A digital device
EMC immunity	according to harmonised standard EN 55020 (1987)
EMC approvals	affixed with the CE mark. EC directive 89/336 EEC
ESD	according to IEC 801-2; contact 4 kV, air 8 kV. Fast transients to the mains and data lines according to IEC 801-4
Additional immunity tests	according to IEC 801-3. Field strength 3 V/m in the frequency range 80 - 1000 MHz. Severity level 3: not affecting normal operation
Mains harmonics	prepared to EN 60555-2 Class A
Other legal requirements	no cadmium used other than in the Nickel-Cadmium battery housed in the central unit
Shock resistance	according to IEC 68.2.29 Eb
Vibration resistance	according to IEC 68.2.6 Fc, procedure A

9.7 Interface data

LBB 3544, 3545, 3546, 3547 Centurus Units' recommended external microphone type (or headset microphone)	
Element:	electret-condenser
Polar pattern	omni-directional
Operating voltage	5 Vd.c.
Sensitivity	approx. -62 dB at 1200 Ω (0 dB = 1 V/μbar at 1 kHz)
Frequency response	100 Hz to 14 kHz
Connector	3.5 mm jack mono or stereo

LBB 3500/05(D), /15(D), /35(D) Central Control Unit	
Nominal power consumption	175 W for LBB 3500/05(D) 350 W for LBB 3500/15(D) and LBB 3500/35(D)
Line in/outputs	-18 dBV/ +12 dBV* (nominal/maximum)
Recorder in/output	-33 dBV/ -3 dBV
Mains voltage	105, 115, 125, 220, 230, 240 Va.c., 50/60 Hz 230 V on delivery (125 V for D units)
* -12dBV/ +18 dBV when used as symmetrical output	

Digital Congress Network

Technical Data

LBB 3506/00(D) Extension Power Supply Unit

Nominal power consumption	350 W
Mains voltage	105, 115, 125, 220, 230, 240 Va.c., 50/60 Hz 230 V on delivery (125 V for D units)

LBB 3508/00(D) Audio Media Interface Unit

Nominal power consumption	175 W
Symmetrical line outputs (XLR)	
- channels 0 up to 11 (interpretation)	1 dBV/ 1 dBV (nominal/maximum)
- channels 12 and 14 (PA)	-8 dBV/ +22 dBV
- channel 13 (delegate loudspeaker)	1 dBV/ +13 dBV
Asymmetrical line outputs (cinch)	
- channels 0 up to 11 (interpretation)	-10 dBV/ -10 dBV (nominal/maximum)
- channels 12 and 14 (PA)	-19 dBV/ +11 dBV
- channel 13 (delegate loudspeaker)	-10 dBV/ +2 dBV
Mains voltage	105, 115, 125, 220, 230, 240 Va.c., 50/60 Hz 230 V on delivery (125 V for D units)

9.8 Power consumption factor

The Power Consumption Factor (PCF) of contribution units connected to a CCU has a bearing on the total number of such units that can be connected. The 'maximum number of units' figure quoted for a CCU is based on all units having a PCF of 1. This means that, for example, a CCU which can accommodate 60 units of PCF 1 can also accommodate 120 units of PCF 0.5. PCFs for DCN contribution equipment are given below:

DCN Unit	Description	PCF
LBB 3510/00	PC Network Card	1
LBB 3512/00	Data Distribution Board	1
LBB 3513/00	Analog Audio Input/Output Module	1
LBB 3514/00	Trunk Splitter	1
LBB 3515/00	Tap-Off Unit	1
LBB 3520/10	Interpreters Unit	2.5
LBB 3524/00	Channel Selector Panel	0.5
LBB 3524/10	Channel Selector Panel with Backlighting	0.5
LBB 3526/10	Channel Selector Panel with Backlighting (large front)	0.5
LBB 3530/xx	Delegate Discussion Unit	1
LBB 3531/xx	Delegate Discussion Unit with Channel Selector	1
LBB 3533/xx	Chairman Discussion Unit	1
LBB 3534/xx	Chairman Discussion Unit with Channel Selector	1
LBB 3535/00	Dual Audio Interface Unit	1.5
LBB 3540/15	Multi-purpose Connection Unit with Chip-Card Reader	2
LBB 3544/00	Delegate Unit	2.5
LBB 3545/00	Delegate Unit with Channel Selector	2.5
LBB 3546/00	Delegate Unit with Graphic LCD and Chip-Card Reader	2.5
LBB 3547/00	Chairman Unit with Graphic LCD and Chip-Card Reader	2.5

Digital Congress Network

Technical Data

9.9 System limits

- The total cable length (using standard LBB 3516/xx cable) between the central control unit and the last unit in any branch of the system must not exceed 250 m (820 ft 2 in). This includes all extension cables and the 2 m (78.74 in) long cable attached to each system unit
- The total length of the extension cable from the central control unit to the first regenerative tap-off (i.e., from Trunk Cable Splitter LBB 3514/00, Audio Media Interface Unit LBB 3508/00 or Extension Power Supply Unit LBB 3506/00) must not exceed 100 m (328 ft 1 in)
- The total length of the extension cable between regenerative tap-offs outputs must not exceed 100 m (328 ft 1 in)
- The maximum distance between table-top contribution units is normally 160 cm (62.99 in). This distance can be increased by using the LBB 3516/xx Extension Cable Assembly

Examples

The examples given below of the LBB 3500/xx, LBB 3506/00 and LBB 3508/00 show the following:

- Maximum number of units that can be connected to a single output
- Maximum number of units that can be connected to all outputs
- Maximum cable length from an output to the last unit

In these examples, the following annotations are used:

TT = Table-Top Discussion Units

DAI = Dual Audio Interface Unit

MPC = Multi-Purpose Connection Unit

CON = Concentus Units

It can be seen by the maximum number given for each type of unit that a Table-Top Discussion Unit requires less current than a Dual Audio Interface Unit or a Multi-Purpose Connection Unit, and therefore more Table-Top Units can be connected to central control equipment. Concentus Units require more current than the above mentioned units.

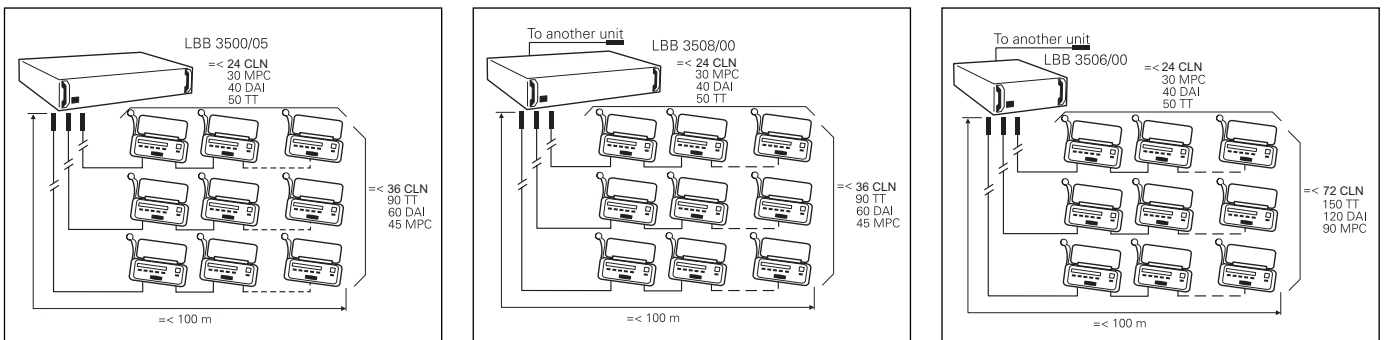

LBB 3500/15, 35 power capacity identical to LBB 3506 power capacity

Digital Congress Network